



**SMARTEC**  
**Z Line-Loop / RCD**  
**MI 3122**  
**Instruction manual**  
*Version 1.4, Code no. 20 751 245*

Distributor:

Manufacturer:

METREL d.d.  
Ljubljanska cesta 77  
1354 Horjul  
Slovenia  
web site: <http://www.metrel.si>  
e-mail: [metrel@metrel.si](mailto:metrel@metrel.si)



Mark on your equipment certifies that this equipment meets the requirements of the EU (European Union) concerning safety and electromagnetic compatibility regulations

© 2013 METREL

*The trade names Metrel, Smartec, Eurotest, Autosequence are trademarks registered or pending in Europe and other countries.*

No part of this publication may be reproduced or utilized in any form or by any means without permission in writing from METREL.

## Table of contents

<b>1</b>	<b>Preface .....</b>	<b>5</b>
<b>2</b>	<b>Safety and operational considerations .....</b>	<b>6</b>
2.1	Warnings and notes.....	6
2.2	Battery and charging.....	8
2.2.1	<i>New battery cells or cells unused for a longer period .....</i>	<i>9</i>
2.3	Standards applied.....	10
<b>3</b>	<b>Instrument description .....</b>	<b>11</b>
3.1	Front panel.....	11
3.2	Connector panel .....	12
3.3	Back site .....	13
3.4	Display organization .....	14
3.4.1	<i>Terminal voltage monitor .....</i>	<i>14</i>
3.4.2	<i>Battery indication .....</i>	<i>14</i>
3.4.3	<i>Message field.....</i>	<i>14</i>
3.4.4	<i>Result field .....</i>	<i>15</i>
3.4.5	<i>Sound warnings .....</i>	<i>15</i>
3.4.6	<i>Help screens .....</i>	<i>15</i>
3.4.7	<i>Backlight and contrast adjustments .....</i>	<i>16</i>
3.5	Instrument set and accessories.....	17
3.5.1	<i>Standard set.....</i>	<i>17</i>
3.5.2	<i>Optional accessories.....</i>	<i>17</i>
<b>4</b>	<b>Instrument operation .....</b>	<b>18</b>
4.1	Function selection.....	18
4.2	Settings.....	19
4.2.1	<i>Language.....</i>	<i>19</i>
4.2.2	<i>Initial settings .....</i>	<i>20</i>
4.2.3	<i>Memory.....</i>	<i>21</i>
4.2.4	<i>Date and time.....</i>	<i>21</i>
4.2.5	<i>RCD standard .....</i>	<i>21</i>
4.2.6	<i>Isc factor .....</i>	<i>23</i>
4.2.7	<i>Commander .....</i>	<i>23</i>
<b>5</b>	<b>Measurements .....</b>	<b>24</b>
5.1	Testing RCDs .....	24
5.1.1	<i>Contact voltage (RCD <math>U_c</math>) .....</i>	<i>25</i>
5.1.2	<i>Trip-out time (RCD <math>t</math>).....</i>	<i>26</i>
5.1.3	<i>Trip-out current (RCD <math>I</math>) .....</i>	<i>27</i>
5.1.4	<i>RCD Autotest.....</i>	<i>27</i>
5.2	Fault loop impedance and prospective fault current.....	30
5.3	Line impedance and prospective short-circuit current .....	32
5.4	Voltage, frequency and phase sequence .....	34
5.5	PE test terminal .....	36
<b>6</b>	<b>Data handling.....</b>	<b>38</b>
6.1	Memory organization .....	38
6.2	Data structure .....	38
6.3	Storing test results .....	40
6.4	Recalling test results.....	40
6.5	Clearing stored data .....	42
6.5.1	<i>Clearing complete memory content .....</i>	<i>42</i>

6.5.2	Clearing measurement(s) in selected location.....	42
6.5.3	Clearing individual measurements.....	43
6.6	Communication.....	44
<b>7</b>	<b>Maintenance.....</b>	<b>45</b>
7.1	Cleaning.....	45
7.2	Periodic calibration .....	45
7.3	Service.....	45
<b>8</b>	<b>Technical specifications.....</b>	<b>46</b>
8.1	RCD testing .....	46
8.1.1	General data .....	46
8.1.2	Contact voltage RCD-U <sub>c</sub> .....	46
8.1.3	Trip-out time.....	47
8.1.4	Trip-out current .....	47
8.2	Fault loop impedance and prospective fault current.....	47
8.2.1	No disconnecting device or FUSE selected.....	47
8.2.2	RCD selected.....	48
8.3	Line impedance and prospective short-circuit current .....	48
8.4	Voltage, frequency, and phase rotation .....	49
8.4.1	Phase rotation.....	49
8.4.2	Voltage.....	49
8.4.3	Frequency.....	49
8.5	Online terminal voltage monitor .....	49
8.6	General data .....	50
<b>A</b>	<b>Appendix A - Fuse table .....</b>	<b>51</b>
A.1	Fuse table - IPSC .....	51
A.2	Fuse table - impedances (UK).....	53
A.3	Fuse table - Impedances at 230 V a.c. (AS/NZS 3017).....	54
<b>B</b>	<b>Appendix B - Accessories for specific measurements.....</b>	<b>56</b>
<b>C</b>	<b>Appendix C – Country notes .....</b>	<b>57</b>
C.1	List of country modifications .....	57
C.2	Modification issues .....	57
C.2.1	AUS / NZ modification – Fuse types according to AS/NZS 3017 .....	57

# 1 Preface

Congratulations on your purchase of the instrument and its accessories from METREL. The instrument was designed on basis of rich experience, acquired through many years of dealing with electric installation test equipment.

The multifunctional hand-held installation tester Smartec Z Line-Loop / RCD is intended for tests and measurements required for inspection of electrical installations in buildings. In general for the following tests and measurements:

- True rms voltage, frequency, and phase sequence,
- Line impedance,
- Loop impedance,
- RCD protection,

The graphic display with backlight offers easy reading of results, indications, measurement parameters and messages. Two LED Pass/Fail indicators are placed at the sides of the LCD.

The operation of the unit is clear and simple – the operator does not need any special training (except reading this instruction manual) to operate the instrument.

In order for operator to be familiar enough with performing measurements in general and their typical applications it is advisable to read Metrel handbook *Guide for testing and verification of low voltage installations*.

The instrument is equipped with all the necessary accessory for comfortable testing.

## 2 Safety and operational considerations

### 2.1 Warnings and notes

In order to reach high level of operator's safety while carrying out various tests and measurements using Smartec Z Line-Loop / RCD, as well as to keep the equipment undamaged, it is necessary to consider the following general warnings:

- ❑  **Warning on the instrument means »Read the Instruction manual with special care to safety operation«. The symbol requires an action!**
- ❑ **If the test equipment is used in a manner not specified in this user manual the protection provided by the equipment might be impaired!**
- ❑ **Read this user manual carefully, otherwise use of the instrument may be dangerous for the operator, for the instrument or for the equipment under test!**
- ❑ **Do not use the instrument and accessories if any damage is noticed!**
- ❑ **Consider all generally known precautions in order to avoid risk of electric shock while dealing with hazardous voltages!**
- ❑ **Do not use the instrument in supply systems with voltages higher than 600 V!**
- ❑ **Service intervention or adjustment and calibration procedure is allowed to be carried out only by a competent authorized person!**
- ❑ **Use only standard or optional test accessories supplied by your distributor!**
- ❑ **Consider that older and some of new optional test accessories compatible with this instrument meet overvoltage category CAT III / 300 V! It means that maximum allowed voltage between test terminals and ground is 300 V!**
- ❑ **Instrument contains rechargeable NiCd or NiMh battery cells. The cells should only be replaced with the same type as defined on the battery placement label or in this manual. Do not use standard alkaline battery cells while power supply adapter is connected, otherwise they may explode!**
- ❑ **Hazardous voltages exist inside the instrument. Disconnect all test leads, remove the power supply cable and switch off the instrument before removing battery compartment cover.**
- ❑ **All normal safety precautions have to be taken in order to avoid risk of electric shock when working on electrical installations!**

**Notes related to measurement functions:**

#### General

- ❑ Indicator  means that the selected measurement can't be performed because of irregular conditions on input terminals.
- ❑ PASS / FAIL indication is enabled when parameters are set. Apply appropriate limit value for evaluation of measurement results.
- ❑ In case that only two of three wires are connected to test electrical installation, only voltage indication between these two wires is valid.

## RCD functions

- ❑ Parameters set in one function are also kept for other RCD functions.
- ❑ The Contact voltage test will normally not trip-out RCD of tested installation. However, the RCD trip-out may occur and  $U_c$  measurement is affected as a result of existing PE leakage currents in the installation.
- ❑ RCD trip-out current and time will be measured only if the contact voltage - pretest passed successfully.
- ❑ L and N test terminals are reversed automatically according to detected terminal voltage (except in UK version).
- ❑ It can happen that the RCD trips-out during the safety pretests. Possible reasons for trip-out are incorrect set RCD parameters ( $I_{\Delta N}$ ), existing leakage currents or defective RCD.

## Z-LOOP

- ❑ The Z-LOOP impedance function will trip-out the RCD in RCD protected installation that is tested. Use the  $Z_{s\ rcd}$  impedance function to prevent the trip-out.
- ❑ The  $Z_{s\ rcd}$  impedance function takes longer time to complete but has much better accuracy than  $R_L$  sub-result in RCD:  $U_c$  function.
- ❑ Specified accuracy of tested parameters is valid only if mains voltage is stable during the measurement.
- ❑ L and N test terminals are reversed automatically according to detected terminal voltage (except in UK version).

## Z-LINE

- ❑ In case of measurement of  $Z_{Line-Line}$  with the instrument test leads PE and N connected together the instrument will display a warning of dangerous PE voltage. The measurement will be performed anyway.
- ❑ Specified accuracy of tested parameters is valid only if mains voltage is stable during the measurement.
- ❑ L and N test terminals are reversed automatically according to detected terminal voltage (except in UK version).

## 2.2 Battery and charging

The instrument uses six AA size alkaline or rechargeable Ni-Cd or Ni-MH battery cells. Nominal operating time is declared for cells with nominal capacity of 2100 mAh.

Battery condition is always displayed in the lower right display part.

In case the battery is too weak the instrument indicates this as shown in figure 2.1. This indication appears for a few seconds and then the instrument turns itself off.

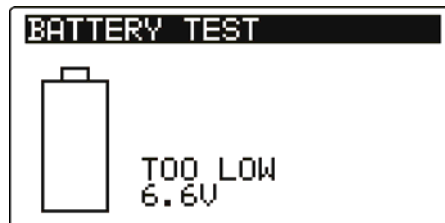

Figure 2.1: Discharged battery indication

The battery is charged whenever the power supply adapter is connected to the instrument. Internal circuit controls charging assuring maximum battery lifetime. The power supply socket polarity is shown in figure 2.2.



Figure 2.2: Power supply socket polarity

The instrument automatically recognizes the connected power supply adapter and begins charging.

Symbols:

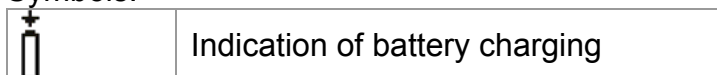

Figure 2.3: Charging indication

- ❑ **⚠ Before opening battery compartment cover disconnect all measuring accessories connected to the instrument and switch off the instrument.**
- ❑ Insert cells correctly, otherwise the instrument will not operate and the batteries could be damaged.
- ❑ Remove all battery cells from the battery compartment if the instrument is not used for a long period of time.
- ❑ **Do not charge alkaline battery cells!**
- ❑ Take into account handling, maintenance and recycling requirements that are defined by related regulations and manufacturers of alkaline or rechargeable batteries!
- ❑ Use only power supply adapter delivered from the manufacturer or distributor of the test equipment to avoid possible fire or electric shock!



## 2.2.1 New battery cells or cells unused for a longer period

Unpredictable chemical processes can occur during charging of new battery cells or cells that were unused for a longer period (more than 3 months). Ni-MH and Ni-Cd battery cells are affected to capacity degradation (sometimes called as memory effect). As a result the instrument operation time can be significantly reduced.

Recommended procedure for recovering battery cells:

Procedure	Notes
➤ Completely <b>charge</b> the battery.	<i>At least 14h with in-built charger.</i>
➤ Completely <b>discharge</b> the battery.	<i>Use the instrument for normal testing until the unit displays the "Bat" symbol on screen.</i>
➤ <b>Repeat</b> the charge / discharge cycle for at least <b>twice</b> .	<i>Four cycles are recommended.</i>

Complete discharge / charge cycle can be performed automatically for each cell using external intelligent battery charger.

### Notes:

- ❑ The charger in the instrument is a pack cell charger. This means that the battery cells are connected in series during the charging. The battery cells have to be equivalent (same charge condition, same type and age).
- ❑ One different battery cell can cause an improper charging and incorrect discharging during normal usage of the entire battery pack (it results in heating of the battery pack, significantly decreased operation time, reversed polarity of defective cell,...).
- ❑ If no improvement is achieved after several charge / discharge cycles, then each battery cell should be checked (by comparing battery voltages, testing them in a cell charger, etc). It is very likely that only some of the battery cells are deteriorated.
- ❑ The effects described above should not be confused with the normal decrease of battery capacity over time. Battery also loses some capacity when it is repeatedly charged / discharged. Actual decreasing of capacity, versus number of charging cycles, depends on battery type. This information is provided in the technical specification from battery manufacturer.

## 2.3 Standards applied

The MI 3122 Smartec Z Line-Loop / RCD instrument is manufactured and tested according to the following regulations, listed below.

### *Electromagnetic compatibility (EMC)*

IEC/ EN 61326-1	Electrical equipment for measurement, control and laboratory use - EMC requirements -- Part 1: General requirements Class B (Hand held equipment used in controlled EM environments)
IEC/EN 61326-2-2	Electrical equipment for measurement, control and laboratory use - EMC requirements -- Part 2-2: Particular requirements - Test configurations, operational conditions and performance criteria for portable test, measuring and monitoring equipment used in low-voltage distribution systems

### *Safety (LVD)*

IEC/ EN 61010 - 1	Safety requirements for electrical equipment for measurement, control, and laboratory use – Part 1: General requirements
IEC/ EN 61010 - 031	Safety requirements for hand-held probe assemblies for electrical measurement and test

### *Functionality*

IEC/ EN 61557	Electrical safety in low voltage distribution systems up to 1000 V a.c. and 1500 V d.c. - Equipment for testing, measuring or monitoring of protective measures
	Part 1 General requirements
	Part 3 Loop resistance
	Part 6 Residual current devices (RCDs) in TT and TN systems
	Part 7 Phase sequence
	Part 10 Combined measuring equipment

### *Other reference standards for testing RCDs*

IEC/ EN 61008	Residual current operated circuit-breakers without integral overcurrent protection for household and similar uses
IEC/ EN 61009	Residual current operated circuit-breakers with integral overcurrent protection for household and similar uses
IEC/ EN 60755	General requirements for residual current operated protective devices
IEC 60364-4-41	Electrical installations of buildings - Part 4-41: Protection for safety - Protection against electric shock
BS 7671	IEE Wiring Regulations
AS / NZ 3760	In-service safety inspection and testing of electrical equipment

## 3 Instrument description

### 3.1 Front panel



Figure 3.1: Front panel

Legend:

1	LCD	128 x 64 dots matrix display with backlight.
2	TEST	Starts measurements. TEST Acts also as the PE touching electrode.
3	UP	Modifies selected parameter.
4	DOWN	
5	MEM	Store / recall / clear tests in memory of instrument.
6	Function selectors	Selects test function.
7	Backlight, Contrast	Changes backlight level and contrast.
8	ON / OFF	Switches the instrument power on or off. <i>The instrument automatically turns off 15 minutes after the last key was pressed.</i>
9	HELP / DISPLAY	Accesses help menus. In RCD Auto toggles between top and bottom parts of results field.
10	TAB	Selects the parameters in selected function.
11	PASS	Indicate acceptance of result.
12	FAIL	

## 3.2 Connector panel

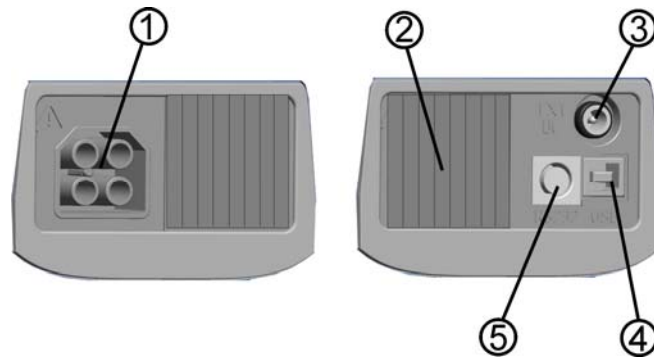

Figure 3.2: Connector panel

Legend:

1	Test connector	Measuring inputs / outputs, connection of measuring cables.
2	Protection cover	Protects from simultaneous access to test connector and power supply adapter socket / communication connectors.
3	Charger socket	Connection of power supply adapter.
4	USB connector	Communication with PC USB (1.1) port.
5	PS/2 connector	Communication with PC serial port and connection to optional measuring adapters.

### Warnings!

- ❑ **Maximum allowed voltage between any test terminal and ground is 600 V!**
- ❑ **Maximum allowed voltage between test terminals is 600 V!**
- ❑ **Maximum short-term voltage of external power supply adapter is 14 V!**

### 3.3 Back site



Figure 3.3: Back site

Legend:

1	Side belt
2	Battery compartment cover
3	Fixing screw for battery compartment cover
4	Back panel information label
5	Holder for inclined position of the instrument
6	Magnet for fixing instrument close to tested item (optional)

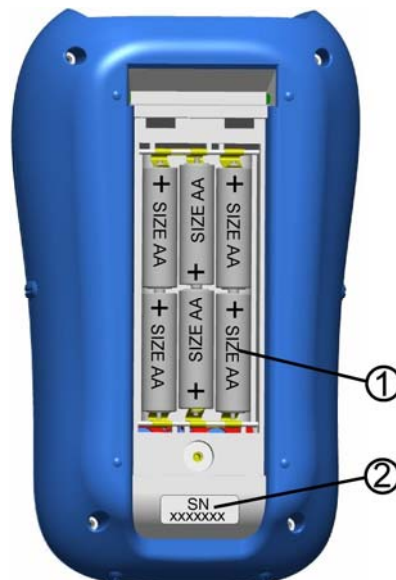

Figure 3.4: Battery compartment

Legend:

1	Battery cells	Size AA, alkaline or rechargeable NiMH / NiCd
2	Serial number label	

### 3.4 Display organization

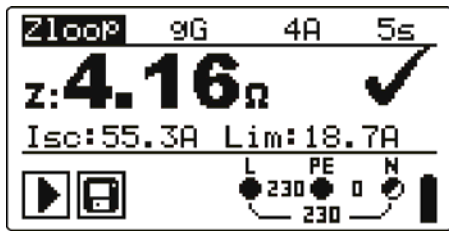

Figure 3.5: Typical function display

Zloop	Function name
z: 4.16 Ω ✓	Result field
Isc: 55.3A Lim: 18.7A 9G 4A 5s	Test parameter field
▶ ⏻	Message field
L 230 PE 0 N 230	Terminal voltage monitor
█	Battery indication

#### 3.4.1 Terminal voltage monitor

The terminal voltage monitor displays on-line the voltages on the test terminals and information about active test terminals.



Online voltage is displayed together, all test terminals are used for selected measurement.

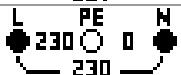

L and N test terminals are used for selected measurement.

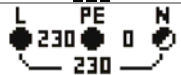

L and PE are active test terminals; N terminal should also be connected for correct input voltage condition.

#### 3.4.2 Battery indication

The indication indicates the charge condition of battery and connection of external charger.



Battery capacity indication.



Low battery.

Battery is too weak to guarantee correct result. Replace or recharge the battery cells.



Recharging in progress (if power supply adapter is connected).

#### 3.4.3 Message field

In the message field warnings and messages are displayed.



Measurement is running, consider displayed warnings.







Conditions on the input terminals allow starting the measurement; consider other displayed warnings and messages.





Conditions on the input terminals do not allow starting the measurement, consider displayed warnings and messages.



RCD tripped-out during the measurement (in RCD functions).

	Instrument is overheated. The measurement is prohibited until the temperature decreases under the allowed limit.
	Result(s) can be stored.
	High electrical noise was detected during measurement. Results may be impaired.
	L – N polarity is changed.
	<b>Warning!</b> Dangerous voltage on the PE terminal! Stop the activity immediately and eliminate the fault / connection problem before proceeding with any activity!

### 3.4.4 Result field

	Measurement result is inside pre-set limits (PASS).
	Measurement result is out of pre-set limits (FAIL).
	Measurement is aborted. Consider displayed warnings and messages.

### 3.4.5 Sound warnings

Continuous sound **Warning!** Dangerous voltage on the PE terminal is detected.

### 3.4.6 Help screens

<b>HELP</b>	Opens help screen.
-------------	--------------------

The help menus contain some basic schematic / connection diagrams to illustrate recommended connection of the instrument to the electrical installation and information about the instrument.

Pressing the **HELP** key in main function menu generates help screen for selected function.

Keys in help menu:

<b>UP / DOWN</b>	Selects next / previous help screen.
<b>HELP</b>	Scrolls through help screens.
<b>Function selectors / TEST</b>	Exits help menu.

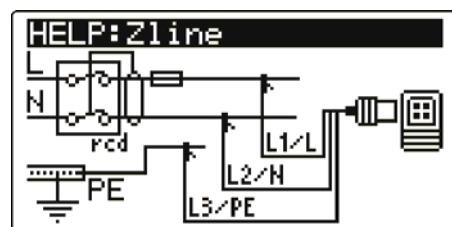
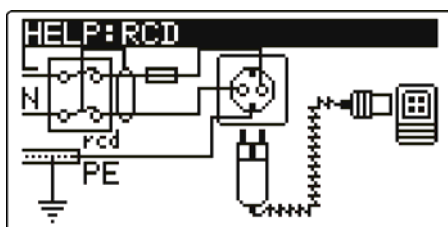

Figure 3.6: Examples of help screens

**Note:**

- Function of the key **Help** is modified to DISPLAY in RCD-Auto.

### 3.4.7 Backlight and contrast adjustments

With the **BACKLIGHT** key backlight and contrast can be adjusted.

<b>Click</b>	Toggles backlight intensity level.
Keep pressed for <b>1 s</b>	Locks high intensity backlight level until power is turned off or the key is pressed again.
Keep pressed for <b>2 s</b>	Bargraph for LCD contrast adjustment is displayed.



Figure 3.7: Contrast adjustment menu

Keys for contrast adjustment:

<b>DOWN</b>	Reduces contrast.
<b>UP</b>	Increases contrast.
<b>TEST</b>	Accepts new contrast.
<b>Function selectors</b>	Exits without changes.



## **3.5 Instrument set and accessories**

### **3.5.1 Standard set**

- ❑ Instrument
- ❑ Short instruction manual
- ❑ Product verification data
- ❑ Warranty declaration
- ❑ Declaration of conformity
- ❑ Mains measuring cable
- ❑ Universal test cable
- ❑ Three test tips
- ❑ Three alligator clips
- ❑ Set of NiMH battery cells
- ❑ Power supply adapter
- ❑ CD with instruction manual, and *“Guide for testing and verification of low voltage installations”* handbook
- ❑ Soft hand strap

### **3.5.2 Optional accessories**

See the attached sheet for a list of optional accessories that are available on request from your distributor.

## 4 Instrument operation

### 4.1 Function selection

For selecting test function the **FUNCTION SELECTOR** shall be used.

Keys:

<b>FUNCTION SELECTOR</b>	Select test / measurement function: <ul style="list-style-type: none"> <li><input type="checkbox"/> &lt;<b>VOLTAGE TRMS</b>&gt; Voltage and frequency and phase sequence.</li> <li><input type="checkbox"/> &lt;<b>Z-LINE</b>&gt; Line impedance.</li> <li><input type="checkbox"/> &lt;<b>Z-LOOP</b>&gt; Fault loop impedance.</li> <li><input type="checkbox"/> &lt;<b>RCD</b>&gt; RCD testing.</li> <li><input type="checkbox"/> &lt;<b>SETTINGS</b>&gt; General settings.</li> </ul>
<b>UP/DOWN</b>	Selects sub-function in selected measurement function.
<b>TAB</b>	Selects the test parameter to be set or modified.
<b>TEST</b>	Runs selected test / measurement function.
<b>MEM</b>	Stores measured results / recalls stored results.

Keys in **test parameter** field:

<b>UP/DOWN</b>	Changes the selected parameter.
<b>TAB</b>	Selects the next measuring parameter.
<b>FUNCTION SELECTOR</b>	Toggles between the main functions.
<b>MEM</b>	Stores measured results / recalls stored results.

General rule regarding enabling **parameters** for evaluation of measurement / test result:

Parameter	<b>OFF</b>	No limit values.
	<b>ON</b>	<b>Value(s)</b> – results will be marked as PASS or FAIL in accordance with selected limit.

See *Chapter 5* for more information about the operation of the instrument test functions.

## 4.2 Settings

Different instrument options can be set in the **SETTINGS** menu.

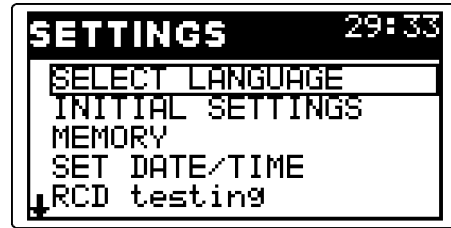

Options are:

- ❑ Selection of language,
- ❑ Setting the instrument to initial values,
- ❑ Recalling and clearing stored results,
- ❑ Setting the date and time,
- ❑ Selection of reference standard for RCD test,
- ❑ Entering Isc factor,
- ❑ Support of commanders.

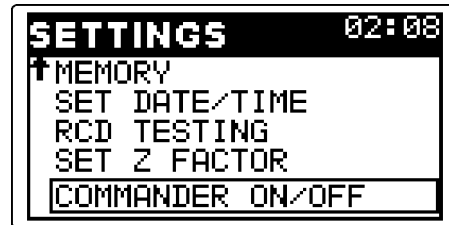
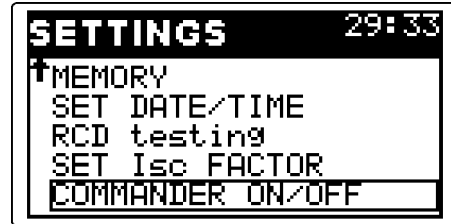

UK version

Figure 4.1: Options in Settings menu

Keys:

<b>UP / DOWN</b>	Selects appropriate option.
<b>TEST</b>	Enters selected option.
<b>Function selectors</b>	Exits back to main function menu.

### 4.2.1 Language

The instrument supports different languages.



Figure 4.2: Language selection

Keys:

<b>UP / DOWN</b>	Selects language.
<b>TEST</b>	Confirms selected language and exits to settings menu.
<b>Function selectors</b>	Exits back to main function menu.

## 4.2.2 Initial settings

Selecting this option will allow the user to reset the instrument settings and measurement parameters and limits to the manufacturers standard values.



Figure 4.3: Initial settings dialogue

Keys:

<b>TEST</b>	Restores default settings.
<b>Function selectors</b>	Exits back to main function menu without changes.

**Warning:**

- ❑ Custom made settings will be lost when this option is used!
- ❑ If the batteries are removed for more than 1 minute the custom made settings will be lost.

The default setup is listed below:

Instrument setting	Default value
Contrast	As defined and stored by adjustment procedure
Isc factor (except in UK version)	1.00
Z factor (UK version only)	0.8
RCD standards	EN 61008 / EN 61009
Language	English

Function Sub-function	Parameters / limit value
Z - LINE	Fuse type: none selected
Z - LOOP	Fuse type: none selected
Zs <sub>rcd</sub>	Fuse type: none selected
RCD	RCD t Nominal differential current: $I_{\Delta N}=30$ mA RCD type: G Test current starting polarity:  (0°) Limit contact voltage: 50 V Current multiplier: $\times 1$

**Note:**

- ❑ Initial settings (reset of the instrument) can be recalled also if the TAB key is pressed while the instrument is switched on.

### 4.2.3 Memory

In this menu the stored data can be recalled and deleted. See chapter 6 *Data handling* for more information.



Figure 4.4: Memory options

Keys:

<b>UP / DOWN</b>	Selects option.
<b>TEST</b>	Enters selected option.
<b>Function selectors</b>	Exits back to main function menu.

### 4.2.4 Date and time

Selecting this option will allow the user to set the date and time of the unit.



Figure 4.5: Setting date and time

Keys:

<b>TAB</b>	Selects the field to be changed.
<b>UP / DOWN</b>	Modifies selected field.
<b>TEST</b>	Confirms new setup and exits.
<b>Function selectors</b>	Exits back to main function menu.

**Warning:**

- If the batteries are removed for more than 1 minute the set time and date will be lost.

### 4.2.5 RCD standard

RCD normative reference can be selected by this option.

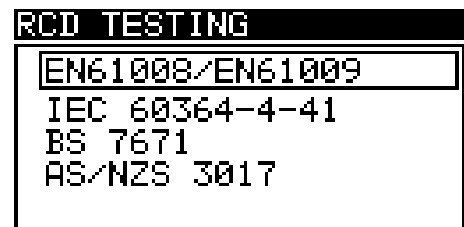

Figure 4.6: Selection of RCD test standard

Keys:

<b>UP / DOWN</b>	Selects standard.
<b>TEST</b>	Confirms selected standard.
<b>Function selectors</b>	Exits back to main function menu.

Maximum RCD disconnection times differ in various standards.  
The trip-out times defined in individual standards are listed below.

Trip-out times according to EN 61008 / EN 61009:

	$\frac{1}{2} \times I_{\Delta N}^{*)}$	$I_{\Delta N}$	$2 \times I_{\Delta N}$	$5 \times I_{\Delta N}$
General RCDs (non-delayed)	$t_{\Delta} > 300$ ms	$t_{\Delta} < 300$ ms	$t_{\Delta} < 150$ ms	$t_{\Delta} < 40$ ms
Selective RCDs (time-delayed)	$t_{\Delta} > 500$ ms	$130 \text{ ms} < t_{\Delta} < 500$ ms	$60 \text{ ms} < t_{\Delta} < 200$ ms	$50 \text{ ms} < t_{\Delta} < 150$ ms

Trip-out times according to IEC 60364-4-41:

	$\frac{1}{2} \times I_{\Delta N}^{*)}$	$I_{\Delta N}$	$2 \times I_{\Delta N}$	$5 \times I_{\Delta N}$
General RCDs (non-delayed)	$t_{\Delta} > 999$ ms	$t_{\Delta} < 999$ ms	$t_{\Delta} < 150$ ms	$t_{\Delta} < 40$ ms
Selective RCDs (time-delayed)	$t_{\Delta} > 999$ ms	$130 \text{ ms} < t_{\Delta} < 999$ ms	$60 \text{ ms} < t_{\Delta} < 200$ ms	$50 \text{ ms} < t_{\Delta} < 150$ ms

Trip-out times according to BS 7671:

	$\frac{1}{2} \times I_{\Delta N}^{*)}$	$I_{\Delta N}$	$2 \times I_{\Delta N}$	$5 \times I_{\Delta N}$
General RCDs (non-delayed)	$t_{\Delta} > 1999$ ms	$t_{\Delta} < 300$ ms	$t_{\Delta} < 150$ ms	$t_{\Delta} < 40$ ms
Selective RCDs (time-delayed)	$t_{\Delta} > 1999$ ms	$130 \text{ ms} < t_{\Delta} < 500$ ms	$60 \text{ ms} < t_{\Delta} < 200$ ms	$50 \text{ ms} < t_{\Delta} < 150$ ms

Trip-out times according to AS/NZS 3017<sup>\*)</sup>:

RCD type	$I_{\Delta N}$ [mA]	$\frac{1}{2} \times I_{\Delta N}^{*)}$ $t_{\Delta}$	$I_{\Delta N}$ $t_{\Delta}$	$2 \times I_{\Delta N}$ $t_{\Delta}$	$5 \times I_{\Delta N}$ $t_{\Delta}$	Note
I	$\leq 10$	$> 999$ ms	40 ms	40 ms	40 ms	Maximum break time
II	$> 10 \leq 30$		300 ms	150 ms	40 ms	
III	$> 30$		300 ms	150 ms	40 ms	
IV 	$> 30$	$> 999$ ms	500 ms	200 ms	150 ms	Minimum non-actuating time
			130 ms	60 ms	50 ms	

<sup>\*)</sup> Minimum test period for current of  $\frac{1}{2} \times I_{\Delta N}$ , RCD shall not trip-out.

<sup>\*\*)</sup> Test current and measurement accuracy correspond to AS/NZS 3017 requirements.

Maximum test times related to selected test current for general (non-delayed) RCD

Standard	$\frac{1}{2} \times I_{\Delta N}$	$I_{\Delta N}$	$2 \times I_{\Delta N}$	$5 \times I_{\Delta N}$
EN 61008 / EN 61009	300 ms	300 ms	150 ms	40 ms
IEC 60364-4-41	1000 ms	1000 ms	150 ms	40 ms
BS 7671	2000 ms	300 ms	150 ms	40 ms
AS/NZS 3017 (I, II, III)	1000 ms	1000 ms	150 ms	40 ms

Maximum test times related to selected test current for selective (time-delayed) RCD

Standard	$\frac{1}{2} \times I_{\Delta N}$	$I_{\Delta N}$	$2 \times I_{\Delta N}$	$5 \times I_{\Delta N}$
EN 61008 / EN 61009	500 ms	500 ms	200 ms	150 ms
IEC 60364-4-41	1000 ms	1000 ms	200 ms	150 ms
BS 7671	2000 ms	500 ms	200 ms	150 ms
AS/NZS 3017 (IV)	1000 ms	1000 ms	200 ms	150 ms

## 4.2.6 Isc factor

Isc factor for calculation of short circuit current in Z-LINE and Z-LOOP can be selected in this menu.

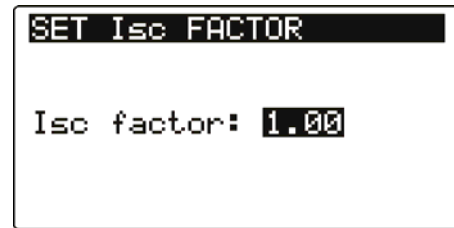

Figure 4.7: Selection of Isc factor

Keys:

<b>UP / DOWN</b>	Sets Isc value.
<b>TEST</b>	Confirms Isc value.
<b>Function selectors</b>	Exits back to main function menu.

Short circuit current Isc in the supply system is important for selection or verification of protective circuit breakers (fuses, over-current breaking devices, RCDs).

The default value of Isc factor (ksc) is 1.00. The value should be set according to local regulative.

Range for adjustment of the Isc factor is 0.20 ÷ 3.00.

### Notes:

- If not defined by other regulations, the recommended value for Isc factor is 0.75÷0.80. This value helps to consider the maximum working temperature for the installation and heating of the wires during a fault.
- In UK version, impedance scaling factor Z is used instead of prospective short/fault scaling factor Isc.

## 4.2.7 Commander

Selecting this option, the support for remote commanders can be switched On/ Off in this menu.

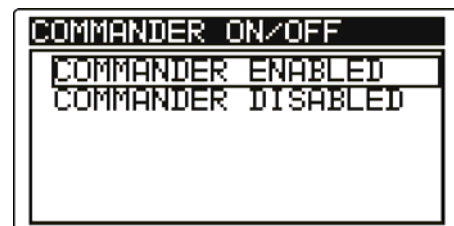

Figure 4.8: Selection of commander support

Keys:

<b>UP / DOWN</b>	Selects commander option.
<b>TEST</b>	Confirms selected option.
<b>Function selectors</b>	Exits back to main function menu.

### Note:

- This option is intended to disable the commander's remote keys. In case of high EM interfering noise the operation of the commander's key can be irregular.

## 5 Measurements

### 5.1 Testing RCDs

Various test and measurements are required for verification of RCD(s) in RCD protected installations. Measurements are based on the EN 61557-6 standard.

The following measurements and tests (sub-functions) can be performed:

- Contact voltage,
- Trip-out time,
- Trip-out current,
- RCD autotest.

See chapter 4.1 *Function selection* for instructions on key functionality.

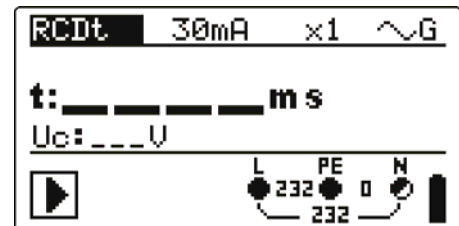

Figure 5.1: RCD test

#### Test parameters for RCD test and measurement

TEST	RCD <b>sub-function</b> test [RCDt, RCD I, AUTO, Uc].
$I_{\Delta N}$	<b>Rated</b> RCD residual current sensitivity $I_{\Delta N}$ [10 mA, 30 mA, 100 mA, 300 mA, 500 mA, 1000 mA].
type	RCD <b>type</b> [G, S], test current <b>waveform</b> plus starting <b>polarity</b> [~G, ~S, ~A, ~V].
MUL	<b>Multiplication</b> factor for test current [ $\frac{1}{2}$ , 1, 2, 5 $I_{\Delta N}$ ].
Ulim	Conventional touch voltage <b>limit</b> [25 V, 50 V].

#### Notes:

- Ulim can be selected in the Uc sub-function only.

The instrument is intended for testing of **G**eneral (non-delayed) and **S**elective (time-delayed) RCDs, which are suited for:

- Alternating residual current (AC type, marked with ~G symbol),
- Pulsating residual current (A type, marked with ~A symbol).
- Time delayed RCDs have delayed response characteristics. As the contact voltage pre-test or other RCD tests influence the time delayed RCD it takes a certain period to recover into normal state. Therefore a time delay of 30 s is inserted before performing trip-out test by default.



## Connections for testing RCD

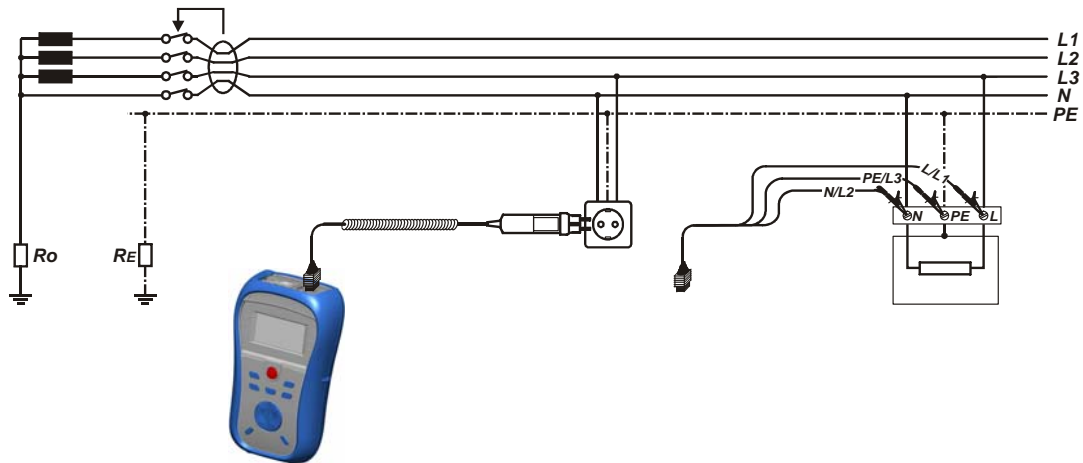

Figure 5.2: Connecting the plug commander and the universal test cable

### 5.1.1 Contact voltage (RCD $U_c$ )

A current flowing into the PE terminal causes a voltage drop on earth resistance, i.e. voltage difference between PE equipotential bonding circuit and earth. This voltage difference is called contact voltage and is present on all accessible conductive parts connected to the PE. It shall always be lower than the conventional safety limit voltage.

The contact voltage is measured with a test current lower than  $\frac{1}{2} I_{\Delta N}$  to avoid trip-out of the RCD and then normalized to the rated  $I_{\Delta N}$ .

#### Contact voltage measurement procedure

- ❑ Select the **RCD** function using the function selector switch.
- ❑ Set sub-function  **$U_c$** .
- ❑ Set test **parameters** (if necessary).
- ❑ **Connect** test cable to the top of the instrument.
- ❑ **Connect** test leads to the item to be tested (see figure 5.2).
- ❑ Press the **TEST** key to perform the measurement.
- ❑ **Store** the result by pressing the MEM key (optional).

The contact voltage result relates to the rated nominal residual current of the RCD and is multiplied by an appropriate factor (depending on RCD type and type of test current). The 1.05 factor is applied to avoid negative tolerance of result. See table 5.1 for detailed contact voltage calculation factors.

RCD type		Contact voltage $U_c$ proportional to	Rated $I_{\Delta N}$
AC	G	$1.05 \times I_{\Delta N}$	any
AC	S	$2 \times 1.05 \times I_{\Delta N}$	
A	G	$1.4 \times 1.05 \times I_{\Delta N}$	$\geq 30 \text{ mA}$
A	S	$2 \times 1.4 \times 1.05 \times I_{\Delta N}$	
A	G	$2 \times 1.05 \times I_{\Delta N}$	$< 30 \text{ mA}$
A	S	$2 \times 2 \times 1.05 \times I_{\Delta N}$	

Table 5.1: Relationship between  $U_c$  and  $I_{\Delta N}$

Loop resistance is indicative and calculated from  $U_c$  result (without additional proportional factors) according to:  $R_L = \frac{U_c}{I_{\Delta N}}$ .

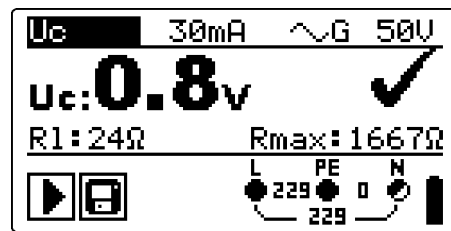
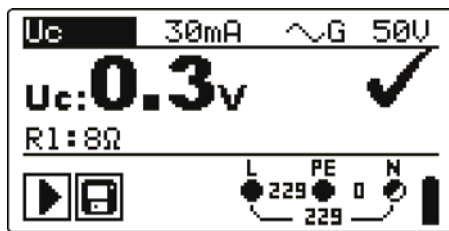

UK version

Figure 5.3: Example of contact voltage measurement results

Displayed results:

$U_c$ ..... Contact voltage.

$R_1$ ..... Fault loop resistance.

$R_{max}$ .. Maximum earth fault loop resistance value according to BS 7671.

### 5.1.2 Trip-out time (RCDt)

Trip-out time measurement verifies the sensitivity of the RCD at different residual currents.

#### Trip-out time measurement procedure

- ❑ Select the **RCD** function using the function selector switch.
- ❑ Set sub-function **RCDt**.
- ❑ Set test **parameters** (if necessary).
- ❑ **Connect** test cable to the top of the instrument.
- ❑ **Connect** test leads to the item to be tested (see *figure 5.2*).
- ❑ Press the **TEST** key to perform the measurement.
- ❑ **Store** the result by pressing the MEM key (optional).

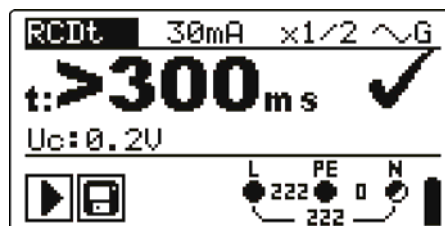

Figure 5.4: Example of trip-out time measurement results

Displayed results:

$t$ ..... Trip-out time,

$U_c$ ..... Contact voltage for rated  $I_{\Delta N}$ .

### 5.1.3 Trip-out current (RCD I)

A continuously rising residual current is intended for testing the threshold sensitivity for RCD trip-out. The instrument increases the test current in small steps through appropriate range as follows:

RCD type	Slope range		Waveform
	Start value	End value	
AC	$0.2 \times I_{\Delta N}$	$1.1 \times I_{\Delta N}$	Sine
A ( $I_{\Delta N} \geq 30 \text{ mA}$ )	$0.2 \times I_{\Delta N}$	$1.5 \times I_{\Delta N}$	Pulsed
A ( $I_{\Delta N} = 10 \text{ mA}$ )	$0.2 \times I_{\Delta N}$	$2.2 \times I_{\Delta N}$	

Maximum test current is  $I_{\Delta}$  (trip-out current) or end value in case the RCD didn't trip-out.

#### Trip-out current measurement procedure

- ❑ Select the **RCD** function using the function selector switch.
- ❑ Set sub-function **RCD I**.
- ❑ Set test **parameters** (if necessary).
- ❑ **Connect** test cable to the top of the instrument.
- ❑ **Connect** test leads to the item to be tested (see figure 5.2).
- ❑ Press the **TEST** key to perform the measurement.
- ❑ **Store** the result by pressing the MEM key (optional).

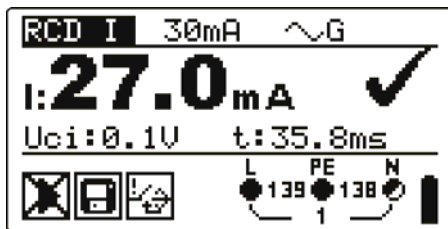

Trip-out

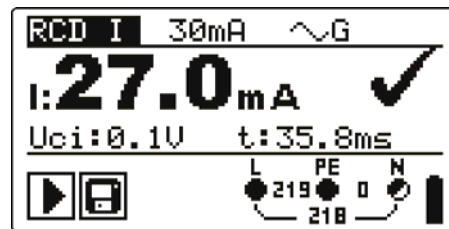

After the RCD is turned on again

Figure 5.5: Trip-out current measurement result example

Displayed results:

I ..... Trip-out current,

Uci ..... Contact voltage at trip-out current I or end value in case the RCD didn't trip,

t ..... Trip-out time.

### 5.1.4 RCD Autotest

RCD autotest function is intended to perform a complete RCD test (trip-out time at different residual currents, trip-out current and contact voltage) in one set of automatic tests, guided by the instrument.

Additional key:

<b>HELP / DISPLAY</b>	Toggles between top and bottom part of results field.
-----------------------	---

## RCD autotest procedure

RCD Autotest steps	Notes
<ul style="list-style-type: none"> <li>□ Select the <b>RCD</b> function using the function selector switch.</li> <li>□ Set sub-function <b>AUTO</b>.</li> <li>□ Set test <b>parameters</b> (if necessary).</li> <li>□ <b>Connect</b> test cable to the top of the instrument.</li> <li>□ <b>Connect</b> test leads to the item to be tested (see <i>figure 5.2</i>).</li> <li>□ Press the <b>TEST</b> key to perform the test.</li> </ul>	Start of test
<ul style="list-style-type: none"> <li>□ Test with <math>I_{\Delta N}</math>, <math>0^\circ</math> (step 1).</li> </ul>	RCD should trip-out
<ul style="list-style-type: none"> <li>□ <b>Re-activate</b> RCD.</li> <li>□ Test with <math>I_{\Delta N}</math>, <math>180^\circ</math> (step 2).</li> </ul>	RCD should trip-out
<ul style="list-style-type: none"> <li>□ <b>Re-activate</b> RCD.</li> <li>□ Test with <math>5 \times I_{\Delta N}</math>, <math>0^\circ</math> (step 3).</li> </ul>	RCD should trip-out
<ul style="list-style-type: none"> <li>□ <b>Re-activate</b> RCD.</li> <li>□ Test with <math>5 \times I_{\Delta N}</math>, <math>180^\circ</math> (step 4).</li> </ul>	RCD should trip-out
<ul style="list-style-type: none"> <li>□ <b>Re-activate</b> RCD.</li> <li>□ Test with <math>\frac{1}{2} \times I_{\Delta N}</math>, <math>0^\circ</math> (step 5).</li> <li>□ Test with <math>\frac{1}{2} \times I_{\Delta N}</math>, <math>180^\circ</math> (step 6).</li> </ul>	RCD should not trip-out RCD should not trip-out
<ul style="list-style-type: none"> <li>□ Trip-out current test, <math>0^\circ</math> (step 7).</li> </ul>	RCD should trip-out
<ul style="list-style-type: none"> <li>□ <b>Re-activate</b> RCD.</li> <li>□ Trip-out current test, <math>180^\circ</math> (step 8).</li> </ul>	RCD should trip-out
<ul style="list-style-type: none"> <li>□ <b>Re-activate</b> RCD.</li> <li>□ <b>Store</b> the result by pressing the MEM key (optional).</li> </ul>	End of test

Result examples:

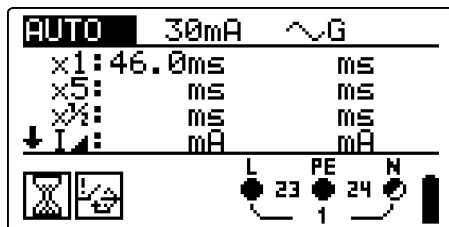

Step 1

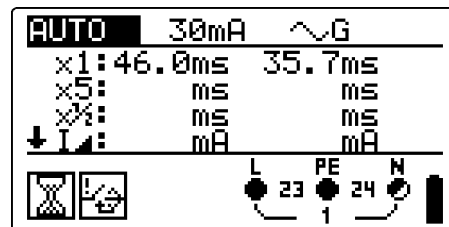

Step 2

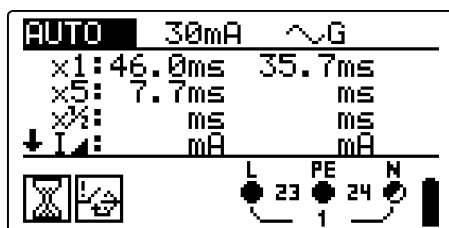

Step 3

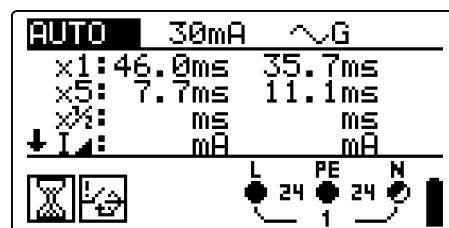

Step 4

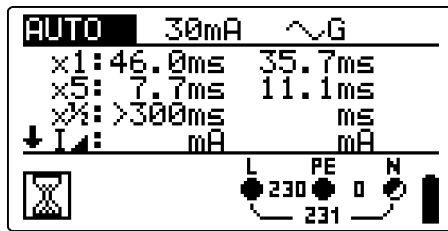

Step 5

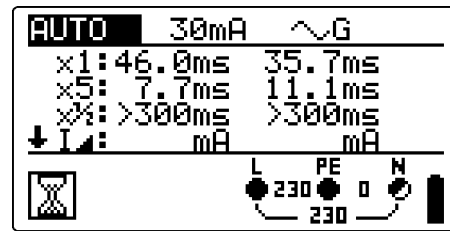

Step 6

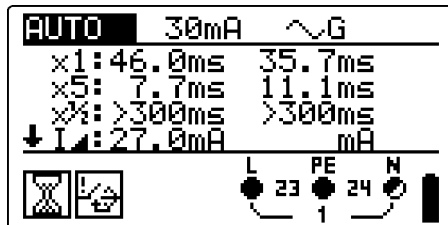

Step 7

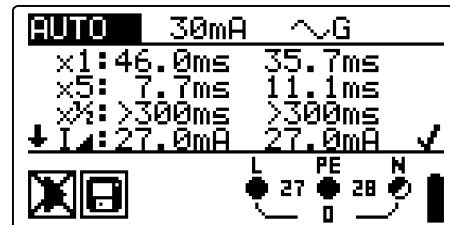

Step 8

Figure 5.6: Individual steps in RCD autotest

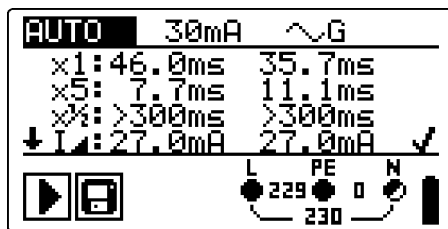

Top

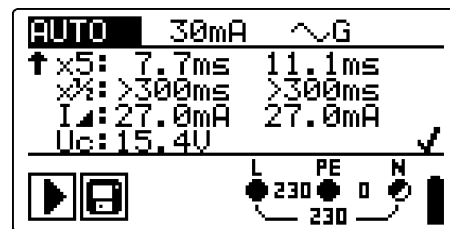

Bottom

Figure 5.7: Two parts of result field in RCD autotest

Displayed results:

- x1 ..... Step 1 trip-out time ( $t_{x1}$ :  $I_{\Delta N}$ ,  $0^\circ$ ),
- x1 ..... Step 2 trip-out time ( $t_{x1}$ :  $I_{\Delta N}$ ,  $180^\circ$ ),
- x5 ..... Step 3 trip-out time ( $t_{x5}$ :  $5 \times I_{\Delta N}$ ,  $0^\circ$ ),
- x5 ..... Step 4 trip-out time ( $t_{x5}$ :  $5 \times I_{\Delta N}$ ,  $180^\circ$ ),
- $x_{1/2}$  ..... Step 5 trip-out time ( $t_{x_{1/2}}$ :  $\frac{1}{2} \times I_{\Delta N}$ ,  $0^\circ$ ),
- $x_{1/2}$  ..... Step 6 trip-out time ( $t_{x_{1/2}}$ :  $\frac{1}{2} \times I_{\Delta N}$ ,  $180^\circ$ ),
- $I_{\Delta}$  ..... Step 7 trip-out current ( $0^\circ$ ),
- $I_{\Delta}$  ..... Step 8 trip-out current ( $180^\circ$ ),
- $U_c$  ..... Contact voltage for rated  $I_{\Delta N}$ .

#### Notes:

- The autotest sequence is immediately stopped if any incorrect condition is detected, e.g. excessive  $U_c$  or trip-out time out of bounds.
- Auto test is finished without x5 tests in case of testing the RCD type A with rated residual currents of  $I_{\Delta n} = 300 \text{ mA}$ ,  $500 \text{ mA}$ , and  $1000 \text{ mA}$ . In this case auto test result passes if all other results pass, and indications for x5 are omitted.
- Tests for sensitivity ( $I_{\Delta}$ , steps 7 and 8) are omitted for selective type RCD.

## 5.2 Fault loop impedance and prospective fault current

Fault loop is a loop comprised by mains source, line wiring and PE return path to the mains source. The instrument measures the impedance of the loop and calculates the short circuit current and contact voltage. The measurement is covered by requirements of the EN 61557-3 standard.

See chapter 4.1 *Function selection* for instructions on key functionality.

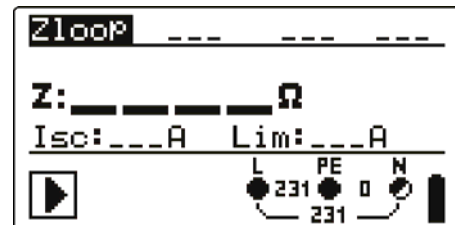

Figure 5.8: Fault loop impedance

### Test parameters for fault loop impedance measurement

Test	Selection of fault loop impedance <b>sub-function</b> [Zloop, Zs rcd]
Fuse type	Selection of <b>fuse type</b> [---, NV, gG, B, C, K, D]
Fuse I	<b>Rated current</b> of selected fuse
Fuse T	Maximum <b>breaking time</b> of selected fuse
Lim	Minimum short circuit <b>current</b> for selected fuse.

See Appendix A for reference fuse data.

### Circuits for measurement of fault loop impedance

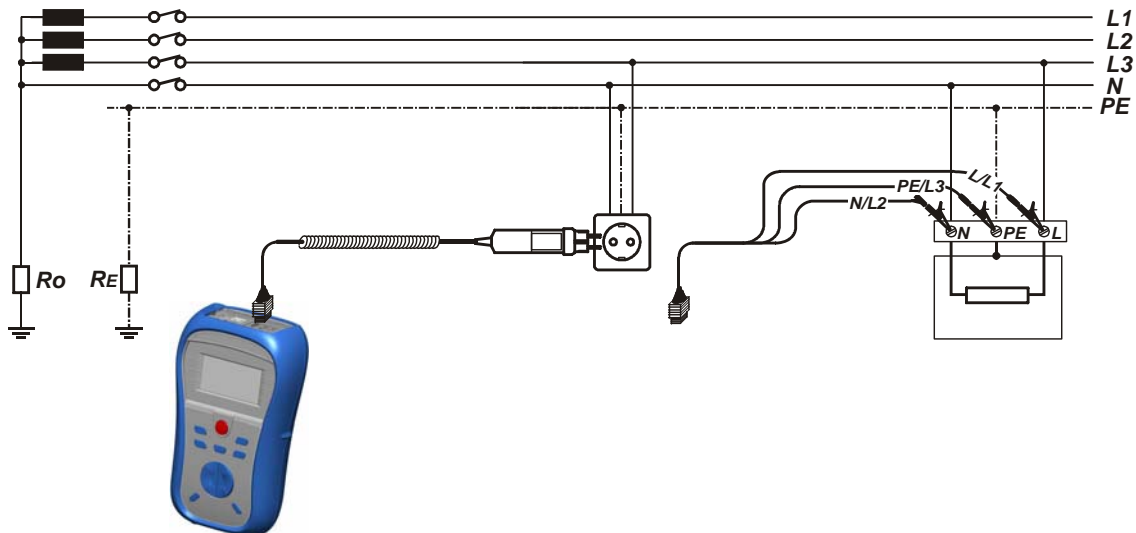
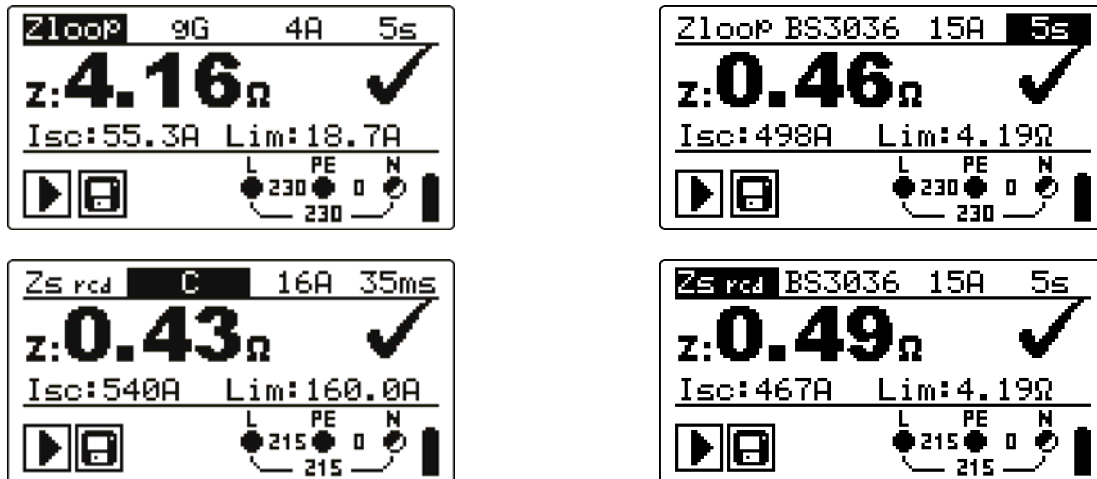

Figure 5.9: Connection of plug cable and universal test cable

### Fault loop impedance measurement procedure

- Select the **Z-LOOP** function using the function selector switch.
- Select test **parameters** (optional).
- **Connect** test cable to the top of the Smartec Z Line-Loop / RCD.
- **Connect** test leads to the item to be tested (see *figure 5.9*).
- Press the **TEST** key to perform the measurement.
- **Store** the result by pressing the MEM key (optional).



UK version

Figure 5.10: Examples of loop impedance measurement result

Displayed results:

Z ..... Fault loop impedance,

Isc ..... Prospective fault current,

Lim ..... Low limit prospective short-circuit current value or high limit fault loop impedance value for the UK version.

Prospective fault current  $I_{SC}$  is calculated from measured impedance as follows:

$$I_{SC} = \frac{U_n \times k_{sc}}{Z}$$

where:

$U_n$  ..... Nominal  $U_{L-PE}$  voltage (see table below),

$k_{sc}$  ..... Correction factor for  $I_{sc}$  (see chapter 4.2.6).

$U_n$	Input voltage range (L-PE)
110 V	$(93 \text{ V} \leq U_{L-PE} \leq 134 \text{ V})$
230 V	$(185 \text{ V} \leq U_{L-PE} \leq 266 \text{ V})$

**Notes:**

- High fluctuations of mains voltage can influence the measurement results (the noise sign  is displayed in the message field). In this case it is recommended to repeat few measurements to check if the readings are stable.
- This measurement will trip-out the RCD in RCD-protected electrical installation if test Zloop is selected.
- Select Zs rcd to prevent trip-out of RCD in RCD protected installation.

## 5.3 Line impedance and prospective short-circuit current

Line impedance is measured in loop comprising of mains voltage source and line wiring. It is covered by requirements of the EN 61557-3 standard.

See chapter 4.1 *Function selection* for instructions on key functionality.

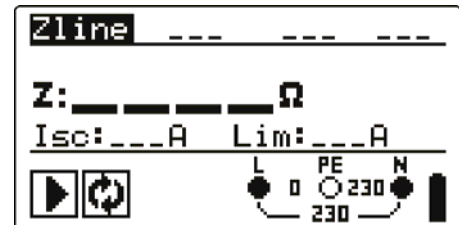

Figure 5.11: Line impedance

### Test parameters for line impedance measurement

FUSE type	Selection of <b>fuse type</b> [---, NV, gG, B, C, K, D]
FUSE I	<b>Rated current</b> of selected fuse
FUSE T	Maximum <b>breaking time</b> of selected fuse
Lim	Minimum short circuit <b>current</b> for selected fuse.

See Appendix A for reference fuse data.

### Connections for measurement of line impedance

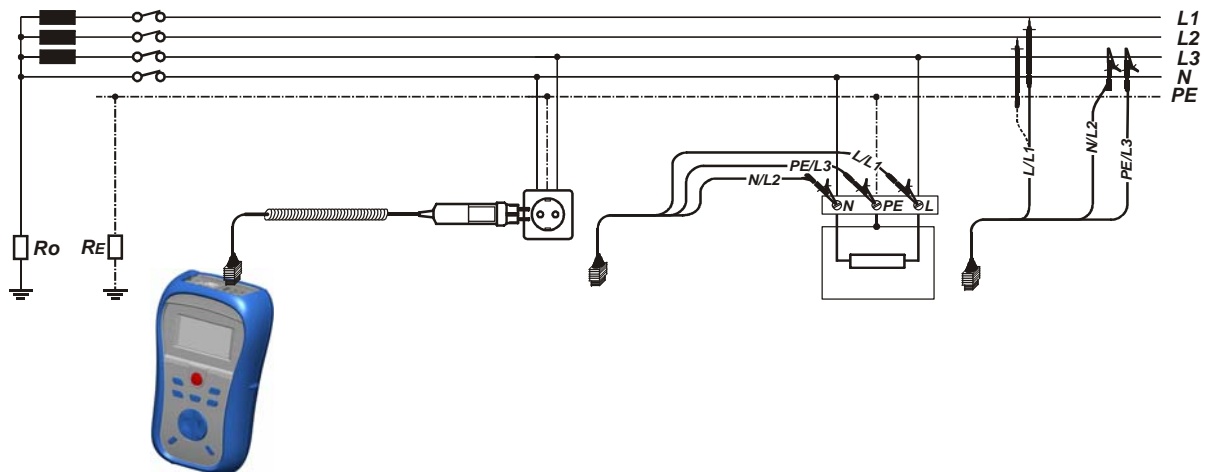

Figure 5.12: Phase-neutral or phase-phase line impedance measurement – connection of plug commander and universal test cable

### Line impedance measurement procedure

- ❑ Select the **Z-LINE** function using the function selector switch.
- ❑ Select test **parameters** (optional).
- ❑ **Connect** test cable to the top of the instrument.
- ❑ **Connect** test leads to the item to be tested (see figure 5.12).
- ❑ Press the **TEST** key to perform the measurement.
- ❑ **Store** the result by pressing the MEM key (optional).



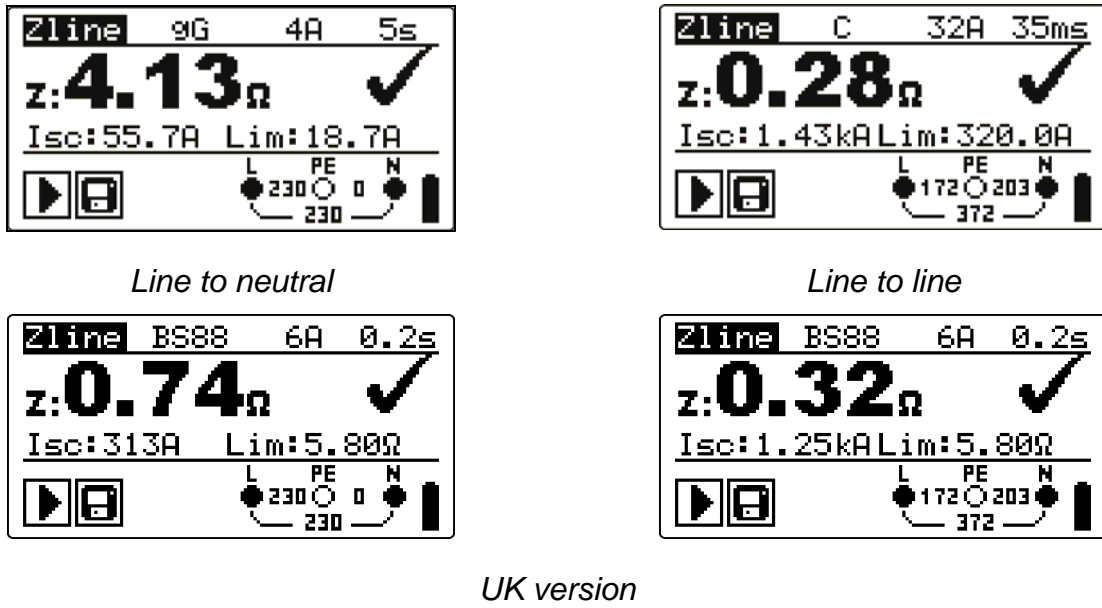

Figure 5.13: Examples of line impedance measurement result

Displayed results:

Z .....Line impedance,

Isc .....Prospective short-circuit current,

Lim .....Low limit prospective short-circuit current value or high limit line impedance value for the UK version.

Prospective short circuit current is calculated as follows:

$$I_{sc} = \frac{U_n \times k_{sc}}{Z}$$

where:

Un .....Nominal L-N or L1-L2 voltage (see table below),

ksc ..... Correction factor for Isc (see chapter 4.2.6).

U <sub>n</sub>	Input voltage range (L-N or L1-L2)
110 V	(93 V ≤ U <sub>L-N</sub> < 134 V)
230 V	(185 V ≤ U <sub>L-N</sub> ≤ 266 V)
400 V	(321 V < U <sub>L-L</sub> ≤ 485 V)

**Note:**

- High fluctuations of mains voltage can influence the measurement results (the noise sign  is displayed in the message field). In this case it is recommended to repeat few measurements to check if the readings are stable.

### 5.4 Voltage, frequency and phase sequence

Voltage and frequency measurement is always active in the terminal voltage monitor. In the special **voltage trms** menu the measured voltage, frequency and information about detected three-phase connection can be stored. Phase sequence measurement conforms to the EN 61557-7 standard.

See chapter 4.1 *Function selection* for instructions on key functionality.

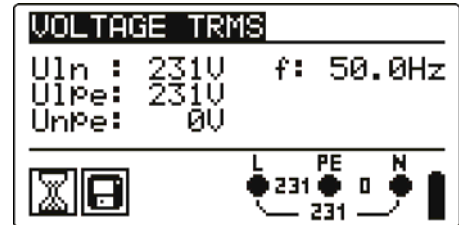

Figure 5.14: Voltage in single phase system

#### Test parameters for voltage measurement

There are no parameters to set.

#### Connections for voltage measurement

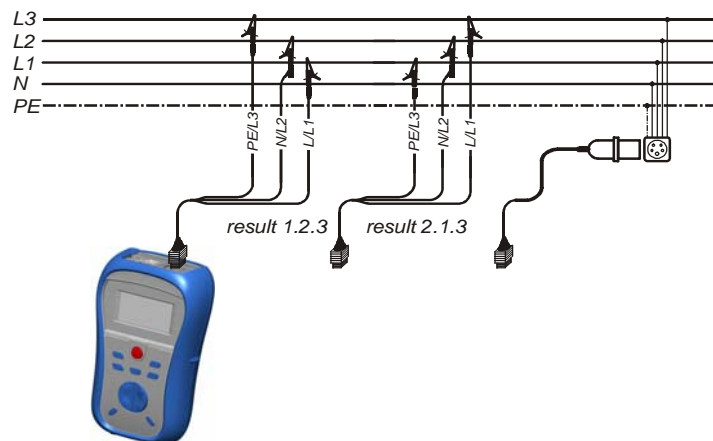

Figure 5.15: Connection of universal test cable and optional adapter in three-phase system

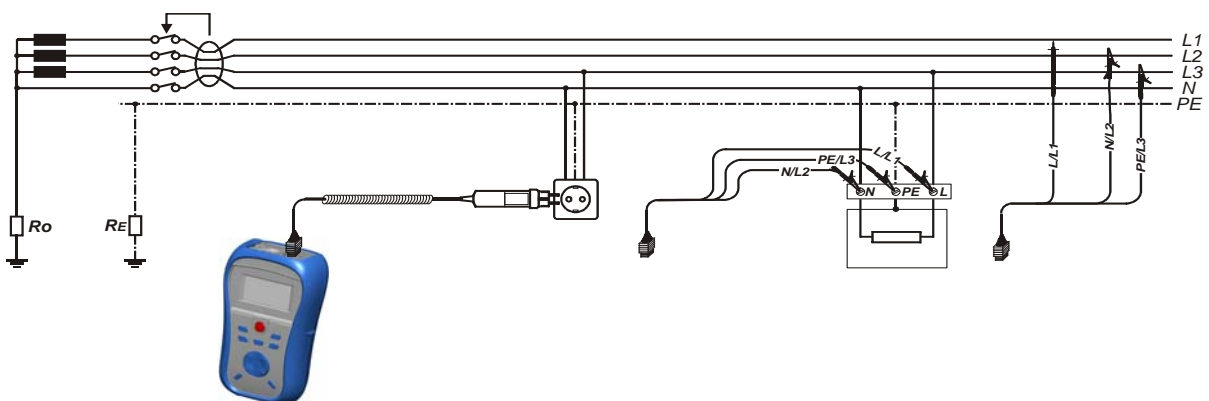

Figure 5.16: Connection of plug commander and universal test cable in single-phase system

**Voltage measurement procedure**

- Select the **VOLTAGE TRMS** function using the function selector switch.
- **Connect** test cable to the top of the instrument.
- **Connect** test leads to the item to be tested (see figures 5.15 and 5.16).
- **Store** current measurement result by pressing the MEM key (optional).

Measurement runs immediately after selection of **VOLTAGE TRMS** function.

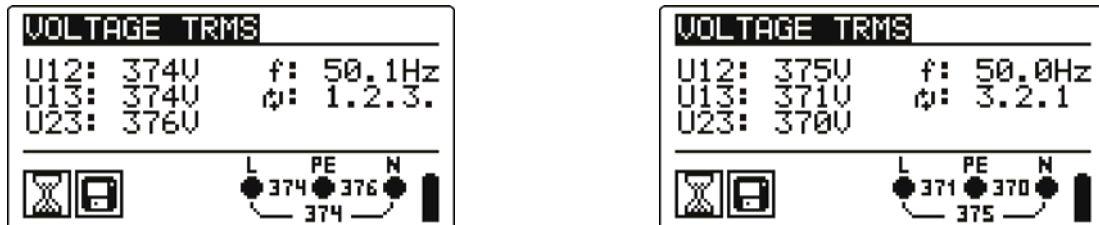

Figure 5.17: Examples of voltage measurement in three-phase system

Displayed results for **single phase** system:

U<sub>ln</sub>..... Voltage between phase and neutral conductors,

U<sub>lpe</sub>..... Voltage between phase and protective conductors,

U<sub>npe</sub>..... Voltage between neutral and protective conductors,

f .....frequency.

Displayed results for **three-phase** system:

U<sub>12</sub>..... Voltage between phases L1 and L2,

U<sub>13</sub>..... Voltage between phases L1 and L3,

U<sub>23</sub>..... Voltage between phases L2 and L3,

1.2.3 ..... Correct connection – CW rotation sequence,

3.2.1 ..... Invalid connection – CCW rotation sequence,

f .....frequency.

## 5.5 PE test terminal

It can happen that a dangerous voltage is applied to the PE wire or other accessible metal parts. This is a very dangerous situation since the PE wire and MPEs are considered to be earthed. An often reason for this fault is incorrect wiring (see examples below).

When touching the **TEST** key in all functions that require mains supply the user automatically performs this test.

### Examples for application of PE test terminal

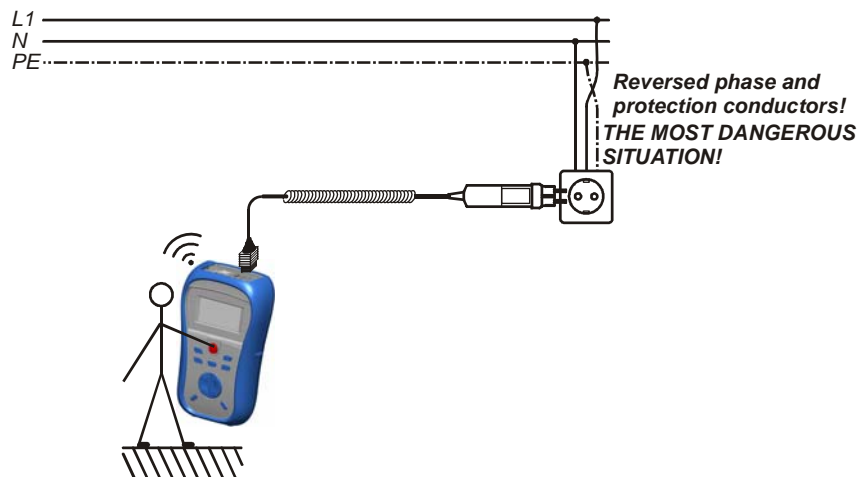

Figure 5.18: Reversed L and PE conductors (application of plug commander)

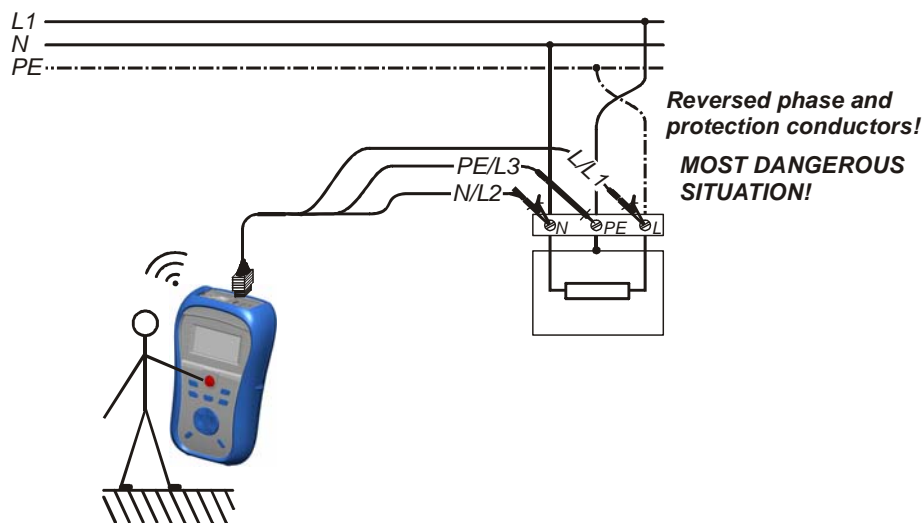

Figure 5.19: Reversed L and PE conductors (application of universal test cable)

**PE terminal test procedure**

- ❑ **Connect** test cable to the top of the instrument.
- ❑ **Connect** test leads to the item to be tested (see *figures 5.18* and *5.19*).
- ❑ Touch PE test probe (the **TEST** key) for at least one second.
- ❑ If PE terminal is connected to phase voltage the warning message is displayed, instrument buzzer is activated, and further measurements are disabled in Z-LOOP and RCD functions.

**Warning:**

- ❑ If dangerous voltage is detected on the tested PE terminal, immediately stop all measurements, find and remove the fault!

**Notes:**

- ❑ In the SETTINGS and VOLTAGE TRMS menus the PE terminal is not tested.
- ❑ PE test terminal does not operate in case the operator's body is completely insulated from floor or walls!

## 6 Data handling

### 6.1 Memory organization

Measurement results together with all relevant parameters can be stored in the instrument's memory.

### 6.2 Data structure

The instrument's memory place is divided into 3 levels each containing 199 locations. The number of measurements that can be stored into one location is not limited.

The **data structure field** describes the identity of the measurement (which object, block, fuse) and where can be accessed.

In the **measurement field** there is information about type and number of measurements that belong to the selected structure element (object and block and fuse).

This organization helps to handle with data in a simple and effective manner.

The main advantages of this system are:

- Test results can be organized and grouped in a structured manner that reflects the structure of typical electrical installations.
- Simple browsing through structures and results.
- Test reports can be created with no or little modifications after downloading results to a PC.

```

RECALL RESULTS
-----
OBJECT: 001
BLOCK: 001
 FUSE: 001
-----
> No.: 2/5
  Zline
  
```

Figure 6.1: Data structure and measurement fields

#### Data structure field

RECALL RESULTS	Memory operation menu
OBJECT: 001 BLOCK: 001 FUSE: 001	Data structure field
OBJECT: 001	Root level in the structure: <ul style="list-style-type: none"> <li>□ <b>OBJECT</b>: 1<sup>st</sup> level location name.</li> <li>□ <b>001</b>: No. of selected object.</li> </ul>
BLOCK: 001	Sub-level (level 2) in the structure: <ul style="list-style-type: none"> <li>□ <b>BLOCK</b>: 2<sup>nd</sup> level location name.</li> <li>□ <b>001</b>: No. of selected system.</li> </ul>
FUSE: 001	Sub-level (level 3) in the structure: <ul style="list-style-type: none"> <li>□ <b>FUSE</b>: 3<sup>rd</sup> level location name.</li> <li>□ <b>001</b>: No. of selected element.</li> </ul>

**Measurement field**

Zline	Type of stored measurement in the selected location.
No.: 2/5	No. of selected test result / No. of all stored test results in selected location.

---

### 6.3 Storing test results

After the completion of a test the results and parameters are ready for storing (📁 icon is displayed in the information field). By pressing the **MEM** key, the user can store the results.

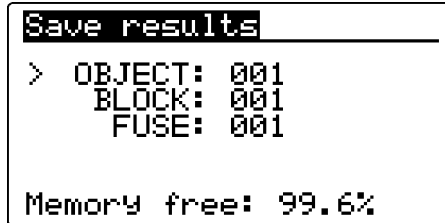

Figure 6.2: Save test menu

Memory free: 99.6% Memory available for storing results.

Keys in save test menu - data structure field:

<b>TAB</b>	Selects the location element (Object / Block / Fuse)
<b>UP / DOWN</b>	Selects number of selected location element (1 to 199)
<b>MEM</b>	Saves test results to the selected location and returns to the measuring menu.
<b>Function selectors / TEST</b>	Exits back to main function menu.

**Notes:**

- ❑ The instrument offers to store the result to the last selected location by default.
- ❑ If the measurement is to be stored to the same location as the previous one just press the **MEM** key twice.

### 6.4 Recalling test results

Press the **MEM** key in a main function menu when there is no result available for storing or select **MEMORY** in the **SETTINGS** menu.

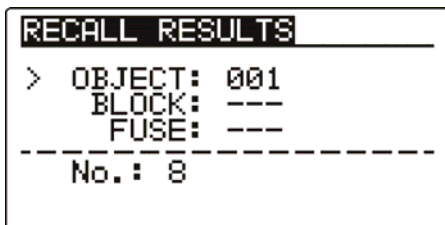

Figure 6.3: Recall menu - data structure field selected

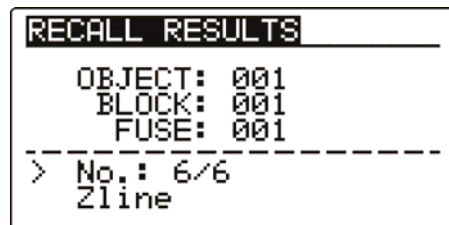

Figure 6.4: Recall menu - measurements field selected



Keys in recall memory menu (data structure field selected):

<b>TAB</b>	Selects the location element (Object / Block / Fuse). Enters measurements field.
<b>UP / DOWN</b>	Selects number of selected location element (1 to 199).
<b>Function selectors / TEST</b>	Exits back to main function menu.

Keys in recall memory menu (measurements field selected):

<b>UP / DOWN</b>	Selects the stored measurement.
<b>MEM</b>	Displays measurement results.
<b>Function selectors / TEST</b>	Exits back to main function menu.

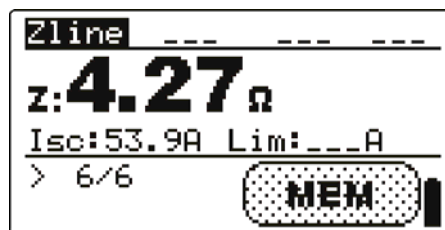

Figure 6.5: Example of recalled measurement result

Keys in recall memory menu (measurement results are displayed)

<b>UP / DOWN</b>	Displays measurement results stored in selected location
<b>MEM / TEST</b>	Return to main MEM menu.
<b>Function selectors</b>	Exit back to main function menu.

## 6.5 Clearing stored data

### 6.5.1 Clearing complete memory content

Select **CLEAR ALL MEMORY** in **MEMORY** menu. A warning (see fig. 6.6) will be displayed.

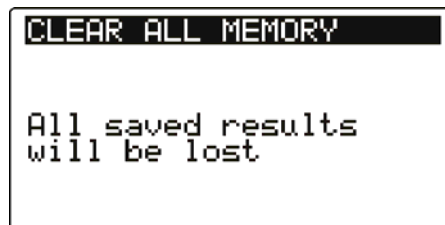

Figure 6.6: Clear all memory

Keys in clear all memory menu

<b>TEST</b>	Confirms clearing of complete memory content.
<b>Function selectors</b>	Exits back to main function menu without changes.

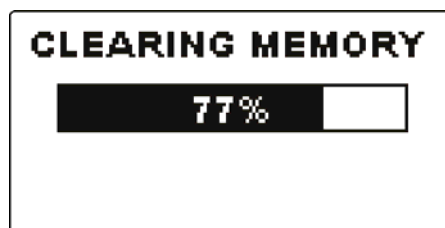

Figure 6.7: Clearing memory in progress

### 6.5.2 Clearing measurement(s) in selected location

Select **DELETE RESULTS** in **MEMORY** menu.

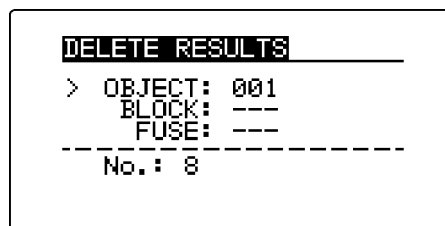

Figure 6.8: Clear measurements menu (data structure field selected)

Keys in delete results menu (data structure field selected):

<b>TAB</b>	Selects location element (Object / Block / Fuse). Enters measurements field.
<b>UP / DOWN</b>	Selects number of selected location element (1 to 199).
<b>Function selectors / MEM</b>	Exits back to main function menu.
<b>TEST</b>	Opens dialog for confirmation to clear result in selected location.

Keys in dialog for confirmation to clear results in selected location:

<b>TEST</b>	Deletes all results in selected location.
<b>MEM</b>	Exits back to delete results menu without changes.
<b>Function selectors</b>	Exits back to main function menu without changes.

### 6.5.3 Clearing individual measurements

Select **DELETE RESULTS** in **MEMORY** menu.

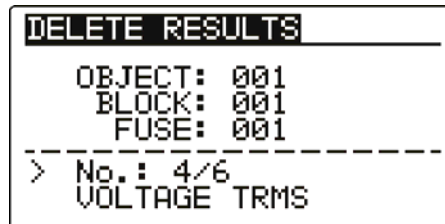

Figure 6.9: Clear measurements menu (data structure field selected)

Keys in delete results menu (measurements field selected)

<b>TAB</b>	Returns to data structure field.
<b>UP / DOWN</b>	Selects measurement.
<b>TEST</b>	Opens dialog for confirmation to clear selected measurement.
<b>Function selectors / MEM</b>	Exits back to main function menu without changes.

Keys in dialog for confirmation to clear selected result(s):

<b>TEST</b>	Deletes selected measurement result.
<b>MEM</b>	Exits back to delete results menu – measurements field without changes.
<b>Function selectors</b>	Exits back to main function menu without changes.

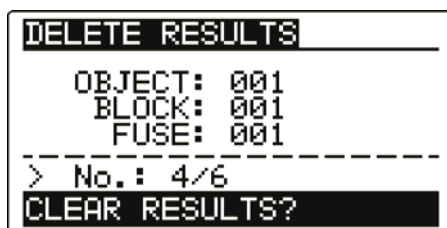

Figure 6.10: Dialog for confirmation

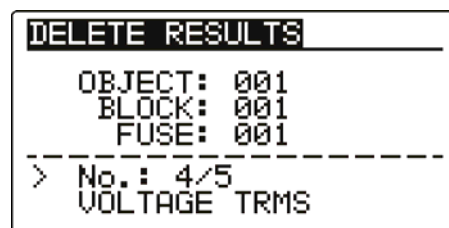

Figure 6.11: Display after measurement was cleared

## 6.6 Communication

Stored results can be transferred to a PC. A special communication program on the PC automatically identifies the instrument and enables data transfer between the instrument and the PC.

There are two communication interfaces available on the instrument: USB or RS 232.

The instrument automatically selects the communication mode according to detected interface. USB interface has priority.

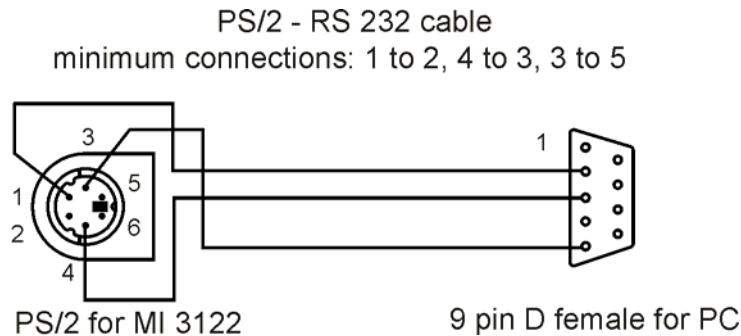

Figure 6.12: Interface connection for data transfer over PC COM port

*How to transfer stored data:*

- ❑ RS 232 communication: connect a PC COM port to the instrument PS/2 connector using the PS/2 - RS232 serial communication cable;
- ❑ USB communication selected: connect a PC USB port to the instrument USB connector using the USB interface cable.
- ❑ Switch **on** the PC and the instrument.
- ❑ **Run** the *EuroLinkPRO* program.
- ❑ The PC and the instrument will automatically recognize each other.
- ❑ The instrument is prepared to download data to the PC.

The program *EuroLinkPRO* is a PC software running on Windows XP, Windows Vista, Windows 7, and Windows 8. Read the file README\_EuroLink.txt on CD for instructions about installing and running the program.

**Note:**

- ❑ USB drivers should be installed on PC before using the USB interface. Refer to USB installation instructions available on installation CD.

## 7 Maintenance

Unauthorized persons are not allowed to open the Smartec Z Line-Loop / RCD instrument. There are no user replaceable components inside the instrument, except the battery under rear cover.

### 7.1 Cleaning

No special maintenance is required for the housing. To clean the surface of the instrument use a soft cloth slightly moistened with soapy water or alcohol. Then leave the instrument to dry totally before use.

#### Warnings:

- ❑ Do not use liquids based on petrol or hydrocarbons!
- ❑ Do not spill cleaning liquid over the instrument!

### 7.2 Periodic calibration

It is essential that the test instrument is regularly calibrated in order that the technical specification listed in this manual is guaranteed. We recommend an annual calibration. Only an authorized technical person can do the calibration. Please contact your dealer for further information.

### 7.3 Service

For repairs under warranty, or at any other time, please contact your distributor.

## 8 Technical specifications

### 8.1 RCD testing

#### 8.1.1 General data

Nominal residual current (A,AC) ..... 10 mA, 30 mA, 100 mA, 300 mA, 500 mA, 1000 mA

Nominal residual current accuracy.... -0 / +0.1·I $\Delta$ ; I $\Delta$  = I $\Delta$ N, 2×I $\Delta$ N, 5×I $\Delta$ N  
-0.1·I $\Delta$  / +0; I $\Delta$  = 0.5×I $\Delta$ N  
AS / NZ selected:  $\pm$  5 %

Test current shape ..... Sine-wave (AC), pulsed (A)

DC offset for pulsed test current ..... 6 mA (typical)

RCD type ..... G (non-delayed), S (time-delayed)

Test current starting polarity ..... 0 ° or 180 °

Voltage range ..... 50 V ÷ 264 V (45 Hz ÷ 65 Hz)

RCD test current selection (r.m.s. value calculated to 20ms) according to IEC 61009:

I $\Delta$ N (mA)	I $\Delta$ N × 1/2		I $\Delta$ N × 1		I $\Delta$ N × 2		I $\Delta$ N × 5		RCD I $\Delta$	
	AC	A	AC	A	AC	A	AC	A	AC	A
10	5	3.5	10	20	20	40	50	100	✓	✓
30	15	10.5	30	42	60	84	150	212	✓	✓
100	50	35	100	141	200	282	500	707	✓	✓
300	150	105	300	424	600	848	1500	n.a.	✓	✓
500	250	175	500	707	1000	1410	2500	n.a.	✓	✓
1000	500	350	1000	1410	2000	n.a.	n.a.	n.a.	✓	✓

n.a..... not applicable

AC type..... sine wave test current

A type..... pulsed current

#### 8.1.2 Contact voltage RCD-Uc

Measuring range according to EN61557 is 20.0 V ÷ 31.0V for limit contact voltage 25V

Measuring range according to EN61557 is 20.0 V ÷ 62.0V for limit contact voltage 50V

Measuring range (V)	Resolution (V)	Accuracy
0.0 ÷ 19.9	0.1	(-0 % / +15 %) of reading $\pm$ 10 digits
20.0 ÷ 99.9		(-0 % / +15 %) of reading

The accuracy is valid if mains voltage is stable during the measurement and PE terminal is free of interfering voltages.

Test current..... max. 0.5×I $\Delta$ N

Limit contact voltage ..... 25 V, 50 V

Specified accuracy is valid for complete operating range.

### 8.1.3 Trip-out time

Complete measurement range corresponds to EN 61557 requirements.  
Maximum measuring times set according to selected reference for RCD testing.

Measuring range (ms)	Resolution (ms)	Accuracy
0.0 ÷ 40.0	0.1	±1 ms
0.0 ÷ max. time *		±3 ms

\* For max. time see normative references in 4.2.6 – this specification applies to max. time >40 ms.

Test current.....  $\frac{1}{2} \times I_{\Delta N}$ ,  $I_{\Delta N}$ ,  $2 \times I_{\Delta N}$ ,  $5 \times I_{\Delta N}$

$5 \times I_{\Delta N}$  is not available for  $I_{\Delta N} = 1000$  mA (RCD type AC) or  $I_{\Delta N} \geq 300$  mA (RCD type A).

$2 \times I_{\Delta N}$  is not available for  $I_{\Delta N} = 1000$  mA (RCD type A).

Specified accuracy is valid for complete operating range.

### 8.1.4 Trip-out current

Trip-out current

Complete measurement range corresponds to EN 61557 requirements.

Measuring range $I_{\Delta}$	Resolution $I_{\Delta}$	Accuracy
$0.2 \times I_{\Delta N} \div 1.1 \times I_{\Delta N}$ (AC type)	$0.05 \times I_{\Delta N}$	$\pm 0.1 \times I_{\Delta N}$
$0.2 \times I_{\Delta N} \div 1.5 \times I_{\Delta N}$ (A type, $I_{\Delta N} \geq 30$ mA)		
$0.2 \times I_{\Delta N} \div 2.2 \times I_{\Delta N}$ (A type, $I_{\Delta N} < 30$ mA)		

Trip-out time

Measuring range (ms)	Resolution (ms)	Accuracy
0 ÷ 300	1	±3 ms

Contact voltage

Measuring range (V)	Resolution (V)	Accuracy
0.0 ÷ 19.9	0.1	(-0 % / +15 %) of reading ± 10 digits
20.0 ÷ 99.9		(-0 % / +15 %) of reading

The accuracy is valid if mains voltage is stable during the measurement and PE terminal is free of interfering voltages.

Specified accuracy is valid for complete operating range.

## 8.2 Fault loop impedance and prospective fault current

### 8.2.1 No disconnecting device or FUSE selected

Fault loop impedance

Measuring range according to EN61557 is  $0.25 \Omega \div 9.99k\Omega$ .

Measuring range ( $\Omega$ )	Resolution ( $\Omega$ )	Accuracy
0.00 ÷ 9.99	0.01	±(5 % of reading + 5 digits)
10.0 ÷ 99.9	0.1	
100 ÷ 999	1	± 10 % of reading
1.00k ÷ 9.99k	10	

Prospective fault current (calculated value)

Measuring range (A)	Resolution (A)	Accuracy
0.00 ÷ 9.99	0.01	Consider accuracy of fault loop resistance measurement
10.0 ÷ 99.9	0.1	
100 ÷ 999	1	
1.00k ÷ 9.99k	10	
10.0k ÷ 23.0k	100	

The accuracy is valid if mains voltage is stable during the measurement.

Test current (at 230 V) ..... 6.5 A (10 ms)

Nominal voltage range ..... 30 V ÷ 500 V (45 Hz ÷ 65 Hz)

### 8.2.2 RCD selected

Fault loop impedance

Measuring range according to EN61557 is 0.46 Ω ÷ 9.99 kΩ.

Measuring range (Ω)	Resolution (Ω)	Accuracy
0.00 ÷ 9.99	0.01	±(5 % of reading + 10 digits)
10.0 ÷ 99.9	0.1	
100 ÷ 999	1	± 10 % of reading
1.00k ÷ 9.99k	10	

Accuracy may be impaired in case of heavy noise on mains voltage

Prospective fault current (calculated value)

Measuring range (A)	Resolution (A)	Accuracy
0.00 ÷ 9.99	0.01	Consider accuracy of fault loop resistance measurement
10.0 ÷ 99.9	0.1	
100 ÷ 999	1	
1.00k ÷ 9.99k	10	
10.0k ÷ 23.0k	100	

Nominal voltage range ..... 30 V ÷ 500 V (45 Hz ÷ 65 Hz)

No trip out of RCD.

### 8.3 Line impedance and prospective short-circuit current

Line impedance

Measuring range according to EN61557 is 0.25 Ω ÷ 9.99kΩ.

Measuring range (Ω)	Resolution (Ω)	Accuracy
0.00 ÷ 9.99	0.01	±(5 % of reading + 5 digits)
10.0 ÷ 99.9	0.1	
100 ÷ 999	1	± 10 % of reading
1.00k ÷ 9.99k	10	



Prospective short-circuit current (calculated value)

Measuring range (A)	Resolution (A)	Accuracy
0.00 ÷ 0.99	0.01	Consider accuracy of line resistance measurement
1.0 ÷ 99.9	0.1	
100 ÷ 999	1	
1.00k ÷ 99.99k	10	
100k ÷ 199k	1000	

Test current (at 230 V) ..... 6.5 A (10 ms)

Nominal voltage range ..... 30 V ÷ 500 V (45 Hz ÷ 65 Hz)

## 8.4 Voltage, frequency, and phase rotation

### 8.4.1 Phase rotation

Nominal system voltage range ..... 100 V<sub>AC</sub> ÷ 550 V<sub>AC</sub>

Nominal frequency range ..... 15 Hz ÷ 500 Hz

Result displayed ..... 1.2.3 or 3.2.1

### 8.4.2 Voltage

Measuring range (V)	Resolution (V)	Accuracy
0 ÷ 550	1	±(2 % of reading + 2 digits)

Result type ..... True r.m.s. (trms)

Nominal frequency range ..... 0 Hz, 15 Hz ÷ 500 Hz

### 8.4.3 Frequency

Measuring range (Hz)	Resolution (Hz)	Accuracy
15.0 ÷ 499.9	0.1	±(0.2 % of reading + 1 digit)

Nominal voltage range ..... 20 V ÷ 550 V

## 8.5 Online terminal voltage monitor

Measuring range (V)	Resolution (V)	Accuracy
0 ÷ 550	1	±(2 % of reading + 2 digits)



## A Appendix A - Fuse table

### A.1 Fuse table - IPSC

#### Fuse type NV

Rated current (A)	Disconnection time [s]				
	35m	0.1	0.2	0.4	5
	Min. prospective short-circuit current (A)				
2	32.5	22.3	18.7	15.9	9.1
4	65.6	46.4	38.8	31.9	18.7
6	102.8	70	56.5	46.4	26.7
10	165.8	115.3	96.5	80.7	46.4
16	206.9	150.8	126.1	107.4	66.3
20	276.8	204.2	170.8	145.5	86.7
25	361.3	257.5	215.4	180.2	109.3
35	618.1	453.2	374	308.7	169.5
50	919.2	640	545	464.2	266.9
63	1217.2	821.7	663.3	545	319.1
80	1567.2	1133.1	964.9	836.5	447.9
100	2075.3	1429	1195.4	1018	585.4
125	2826.3	2006	1708.3	1454.8	765.1
160	3538.2	2485.1	2042.1	1678.1	947.9
200	4555.5	3488.5	2970.8	2529.9	1354.5
250	6032.4	4399.6	3615.3	2918.2	1590.6
315	7766.8	6066.6	4985.1	4096.4	2272.9
400	10577.7	7929.1	6632.9	5450.5	2766.1
500	13619	10933.5	8825.4	7515.7	3952.7
630	19619.3	14037.4	11534.9	9310.9	4985.1
710	19712.3	17766.9	14341.3	11996.9	6423.2
800	25260.3	20059.8	16192.1	13545.1	7252.1
1000	34402.1	23555.5	19356.3	16192.1	9146.2
1250	45555.1	36152.6	29182.1	24411.6	13070.1

#### Fuse type gG

Rated current (A)	Disconnection time [s]				
	35m	0.1	0.2	0.4	5
	Min. prospective short-circuit current (A)				
2	32.5	22.3	18.7	15.9	9.1
4	65.6	46.4	38.8	31.9	18.7
6	102.8	70	56.5	46.4	26.7
10	165.8	115.3	96.5	80.7	46.4
13	193.1	144.8	117.9	100	56.2
16	206.9	150.8	126.1	107.4	66.3
20	276.8	204.2	170.8	145.5	86.7
25	361.3	257.5	215.4	180.2	109.3
32	539.1	361.5	307.9	271.7	159.1
35	618.1	453.2	374	308.7	169.5
40	694.2	464.2	381.4	319.1	190.1
50	919.2	640	545	464.2	266.9
63	1217.2	821.7	663.3	545	319.1
80	1567.2	1133.1	964.9	836.5	447.9
100	2075.3	1429	1195.4	1018	585.4

**Fuse type B**

Rated current (A)	Disconnection time [s]				
	35m	0.1	0.2	0.4	5
	Min. prospective short-circuit current (A)				
6	30	30	30	30	30
10	50	50	50	50	50
13	65	65	65	65	65
15	75	75	75	75	75
16	80	80	80	80	80
20	100	100	100	100	100
25	125	125	125	125	125
32	160	160	160	160	160
40	200	200	200	200	200
50	250	250	250	250	250
63	315	315	315	315	315

**Fuse type C**

Rated current (A)	Disconnection time [s]				
	35m	0.1	0.2	0.4	5
	Min. prospective short-circuit current (A)				
0.5	5	5	5	5	2.7
1	10	10	10	10	5.4
1.6	16	16	16	16	8.6
2	20	20	20	20	10.8
4	40	40	40	40	21.6
6	60	60	60	60	32.4
10	100	100	100	100	54
13	130	130	130	130	70.2
15	150	150	150	150	83
16	160	160	160	160	86.4
20	200	200	200	200	108
25	250	250	250	250	135
32	320	320	320	320	172.8
40	400	400	400	400	216
50	500	500	500	500	270
63	630	630	630	630	340.2

**Fuse type K**

Rated current (A)	Disconnection time [s]				
	35m	0.1	0.2	0.4	
	Min. prospective short-circuit current (A)				
0.5	7.5	7.5	7.5	7.5	
1	15	15	15	15	
1.6	24	24	24	24	
2	30	30	30	30	
4	60	60	60	60	
6	90	90	90	90	
10	150	150	150	150	
13	195	195	195	195	
15	225	225	225	225	
16	240	240	240	240	
20	300	300	300	300	
25	375	375	375	375	
32	480	480	480	480	

**Fuse type D**

Rated current (A)	Disconnection time [s]				
	35m	0.1	0.2	0.4	5
	Min. prospective short-circuit current (A)				
0.5	10	10	10	10	2.7
1	20	20	20	20	5.4
1.6	32	32	32	32	8.6
2	40	40	40	40	10.8
4	80	80	80	80	21.6
6	120	120	120	120	32.4
10	200	200	200	200	54
13	260	260	260	260	70.2
15	300	300	300	300	81
16	320	320	320	320	86.4
20	400	400	400	400	108
25	500	500	500	500	135
32	640	640	640	640	172.8

**A.2 Fuse table - impedances (UK)****Fuse type B****Fuse type C**

Rated current (A)	Disconnection time [s]		Rated current (A)	Disconnection time [s]	
	0.4	5		0.4	5
	Max. loop impedance ( $\Omega$ )			Max. loop impedance ( $\Omega$ )	
3	12,264	12,264			
6	6,136	6,136	6	3,064	3,064
10	3,68	3,68	10	1,84	1,84
16	2,296	2,296	16	1,152	1,152
20	1,84	1,84	20	0,92	0,92
25	1,472	1,472	25	0,736	0,736
32	1,152	1,152	32	0,576	0,576
40	0,92	0,92	40	0,456	0,456
50	0,736	0,736	50	0,368	0,368
63	0,584	0,584	63	0,288	0,288
80	0,456	0,456	80	0,232	0,232
100	0,368	0,368	100	0,184	0,184
125	0,296	0,296	125	0,144	0,144

**Fuse type D****Fuse type BS 88-3 (system C)**

Rated current (A)	Disconnection time [s]		Rated current (A)	Disconnection time [s]	
	0.4	5		0.4	5
	Max. loop impedance ( $\Omega$ )			Max. loop impedance ( $\Omega$ )	
6	1,536	1,536	5	8,36	12,264
10	0,92	0,92	16	1,936	3,288
16	0,576	0,576	20	1,632	2,704
20	0,456	0,456	32	0,768	1,312
25	0,368	0,368	45		0,832
32	0,288	0,288	63		0,576
40	0,232	0,232	80		0,424
50	0,184	0,184	100		0,32
63	0,144	0,144			

80		0,112	0,112				
100		0,088	0,088				
125		0,072	0,072				

**Fuse type BS 88-2 (systems E and G)****Fuse type BS 1362**

Rated current (A)	Disconnection time [s]			Rated current (A)	Disconnection time [s]		
		0.4	5			0.4	5
	<b>Max. loop impedance (<math>\Omega</math>)</b>				<b>Max. loop impedance (<math>\Omega</math>)</b>		
6		6,568	10,24	3		13,12	18,56
10		3,912	5,752	13		1,936	3,064
16		2,048	3,344	<b>Fuse type BS 3036</b>			
20		1,416	2,36				
25		1,08	1,84	Rated current (A)	Disconnection time [s]		
32		0,832	1,472			0.4	5
40			1,08	<b>Max. loop impedance (<math>\Omega</math>)</b>			
50			0,832	5		7,664	14,16
63			0,656	15		2,04	4,28
80			0,456	20		1,416	3,064
100			0,368	30		0,872	2,112
125			0,272	45			1,272
160			0,224	60			0,896
200			0,152	100			0,424

All impedances are scaled with factor 0.8.

**A.3 Fuse table - Impedances at 230 V a.c. (AS/NZS 3017)****Type B****Type C**

Rated current (A)	Disconnection time [s]			Rated current (A)	Disconnection time [s]		
		0.4				0.4	
	<b>Max. loop impedance (<math>\Omega</math>)</b>				<b>Max. loop impedance (<math>\Omega</math>)</b>		
6		9.58		6		5.11	
10		5.75		10		3.07	
16		3.59		16		1.92	
20		2.88		20		1.53	
25		2.30		25		1.23	
32		1.80		32		0.96	
40		1.44		40		0.77	
50		1.15		50		0.61	
63		0.91		63		0.49	
80		0.72		80		0.38	
100		0.58		100		0.31	
125		0.46		125		0.25	
160		0.36		160		0.19	
200		0.29		200		0.15	

<b>Type D</b>			<b>Fuse</b>				
Rated current (A)	Disconnection time [s]			Rated current (A)	Disconnection time [s]		
		0.4				0.4	5
	Max. loop impedance ( $\Omega$ )				Max. loop impedance ( $\Omega$ )		
6		3.07		6	11.50	15.33	
10		1.84		10	6.39	9.20	
16		1.15		16	3.07	5.00	
20		0.92		20	2.09	3.59	
25		0.74		25	1.64	2.71	
32		0.58		32	1.28	2.19	
40		0.46		40	0.96	1.64	
50		0.37		50	0.72	1.28	
63		0.29		63	0.55	0.94	
80		0.23		80	0.38	0.68	
100		0.18		100	0.27	0.48	
125		0.15		125	0.21	0.43	
160		0.12		160	0.16	0.30	
200		0.09		200	0.13	0.23	

All impedances are scaled with factor 1.00.

## B Appendix B - Accessories for specific measurements

The table below presents standard and optional accessories required for specific measurement. The accessories marked as optional may also be standard ones in some sets. Please see attached list of standard accessories for your set or contact your distributor for further information.

Function	Suitable accessories (Optional with ordering code A....)
Line impedance	<input type="checkbox"/> Universal test cable <input type="checkbox"/> Plug commander (A 1272) <input type="checkbox"/> Mains measuring cable <input type="checkbox"/> Tip commander (A 1270) <input type="checkbox"/> Three-phase adapter (A 1111)
Fault loop impedance	<input type="checkbox"/> Universal test cable <input type="checkbox"/> Plug commander (A 1272) <input type="checkbox"/> Mains measuring cable <input type="checkbox"/> Tip commander (A 1270) <input type="checkbox"/> Three-phase adapter (A 1111)
RCD testing	<input type="checkbox"/> Universal test cable <input type="checkbox"/> Plug commander (A 1272) <input type="checkbox"/> Mains measuring cable <input type="checkbox"/> Three-phase adapter (A 1111)
Phase sequence	<input type="checkbox"/> Universal test cable <input type="checkbox"/> Three-phase cable (A 1110) <input type="checkbox"/> Three-phase adapter (A 1111)
Voltage, frequency	<input type="checkbox"/> Universal test cable <input type="checkbox"/> Plug commander (A 1272) <input type="checkbox"/> Mains measuring cable <input type="checkbox"/> Tip commander (A 1272)



## C Appendix C – Country notes

This appendix C contains collection of minor modifications related to particular country requirements. Some of the modifications mean modified listed function characteristics related to main chapters and others are additional functions. Some minor modifications are related also to different requirements of the same market that are covered by various suppliers.

### C.1 List of country modifications

The following table contains current list of applied modifications.

Country	Related chapters	Modification type	Note
AUS / NZ	4.2.2, 4.2.6, 5.2, 5.3, Appendix A	Appended	AUS / NZ fuse table added

### C.2 Modification issues

#### C.2.1 AUS / NZ modification – Fuse types according to AS/NZS 3017

*Modifications of the chapter 4.2.2*

The default setup is listed below:

Instrument setting	Default value
Z factor	1.00
RCD standards	AS/NZS 3017

*Modifications of the chapter 4.2.6*

##### C.2.1.1 Z Factor

In this menu the Z factor can be set.

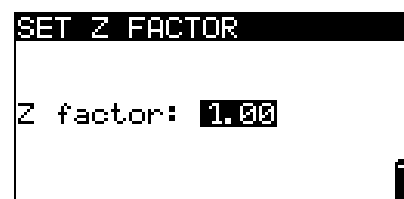

Figure 4.7: Selection of Z factor

Keys:

<b>UP / DOWN</b>	Sets Z value.
<b>TEST</b>	Confirms Z value.
<b>Function selectors</b>	Exits back to main function menu.

The impedance limit values for different overcurrent protective devices depend on nominal voltage and are calculated using the Z factor. Z factor 1.00 is used for nominal voltage 230 V and Z factor 1.04 is used for nominal voltage 240 V.

Modifications of the chapter 5.2

**Modified test parameters for fault loop impedance measurement**

Fuse type	Selection of <b>fuse type</b> [---, FUSE, B, C, D]
Lim	<b>High limit fault loop impedance value</b> for selected fuse.

See Appendix A.3 for reference fuse data.

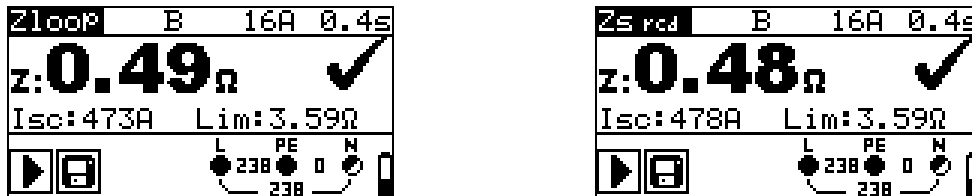

Figure 5.10: Examples of loop impedance measurement result

Displayed results:

- Z** fault loop impedance
- Isc** .....prospective fault current,
- Lim**.....high limit fault loop impedance value.

Prospective fault current  $I_{PFC}$  is calculated from measured impedance as follows:

$$I_{PFC} = \frac{U_N}{Z_{L-PE} \cdot scaling\_factor}$$

where:

- $U_n$  Nominal  $U_{L-PE}$  voltage (see table below),
- scaling\_factor ..... Correction factor for Isc (set to 1.00).

$U_n$	Input voltage range (L-PE)
110 V	$(93\text{ V} \leq U_{L-PE} \leq 134\text{ V})$
230 V	$(185\text{ V} \leq U_{L-PE} \leq 266\text{ V})$

Modifications of the chapter 5.3

**Modified test parameters for line impedance measurement**

Fuse type	Selection of <b>fuse type</b> [---, FUSE, B, C, D]
Lim	<b>High limit line impedance value</b> for selected fuse.

See Appendix A.3 for reference fuse data.

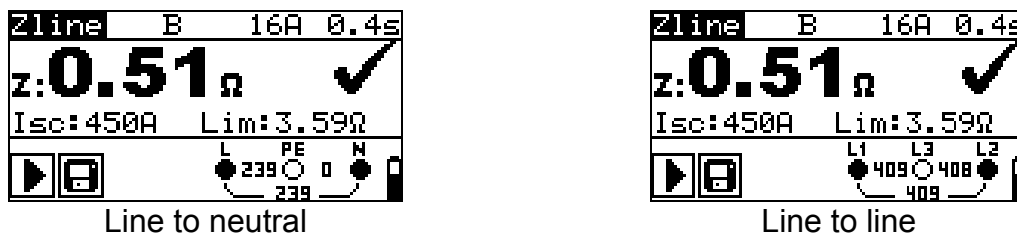

Figure 5.13: Examples of line impedance measurement result

Displayed results:

**Z** line impedance

**Isc** .....prospective short-circuit current

**Lim**.....high limit line impedance value.

Prospective fault current  $I_{PFC}$  is calculated from measured impedance as follows:

$$I_{PFC} = \frac{U_N}{Z_{L-N(L)} \cdot scaling\_factor}$$

where:

$U_n$  Nominal  $U_{L-N}$  or  $U_{L1-L2}$  voltage (see table below),

Scaling factor ..... Correction factor for Isc (set to 1.00).

$U_n$	Input voltage range (L-N or L1-L2)
110 V	$(93\text{ V} \leq U_{L-N} < 134\text{ V})$
230 V	$(185\text{ V} \leq U_{L-N} \leq 266\text{ V})$
400 V	$(321\text{ V} < U_{L-L} \leq 485\text{ V})$